



INNOVATION FOR SCREWS FASTENING

K02012.2



INNOVATION FOR SCREWS FASTENING

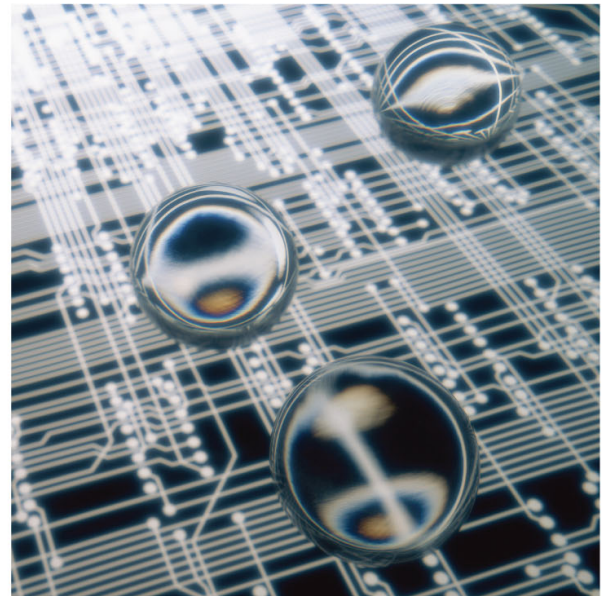
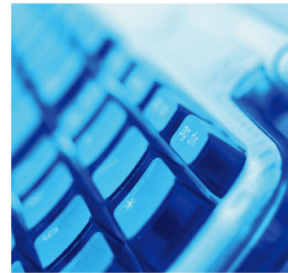
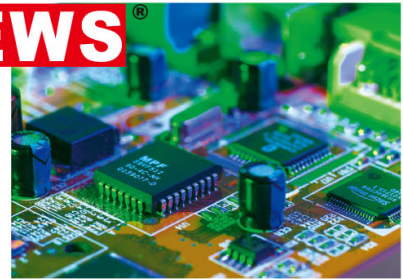

CATALOGUE

Index

COMPANY PROFILE	1.
TABLE OF ALL MODELS CHART	2.
TORQUE OF ALL MODELS	3.
SCREWDRIVERS MODEL RECOGNIZE DESCRIPTION	4.
BRUSHLESS SCREWDRIVERS POWER CONTROLLER	
SKP-32B-60W, SKP-BE32HL, SKP-40B	5.
BRUSHLESS POWER TORQUE DC-TYPE AUTOMATIC SERIES	
RB Series SKD-RB75L/P, SKD-RB100L/P, SKD-RB120L/P, SKD-RB180L/P	6.
TB Series SKD-TB75L, SKD-TB100L, SKD-TB120L, SKD-TB180L	6.
BRUSHLESS HIGH TORQUE DC-TYPE AUTOMATIC SERIES	
B800 Series SKD-B830L/P(LF/PF), SKD-B850L/P	7.
BRUSHLESS WITH COUNTER DC-TYPE AUTOMATIC SERIES	
BE800 Series SKD-BE830L/P(LF/PF), SKD-BE850L/P	8.
FIRST SMALLEST BRUSHLESS SCREWDRIVERS IN THE WORLD MINI LOW TORQUE SERIES	
B100 Series SKD-B100L, SKD-B103L	9.
BRUSHLESS LOW & MEDIUM TORQUE DC-TYPE AUTOMATIC SERIES	
B200 Series SKD-B203L, SKD-B207L, SKD-B210L	10.
B500 Series SKD-B512L/P(LF/PF), SKD-B517LF/PF, SKD-B519L/P	10.
BRUSHLESS WITH COUNTER DC-TYPE AUTOMATIC SERIES	
BE500 Series SKD-BE512L/P(LF/PF), SKD-BE517LF/PF, SKD-BE519L/P	11.
BRUSHLESS SCREW COUNTER	
SKP-BC40HL(Counter / Power Supply / Slow-Start)	12.
SKP-BC32HL(Counter / Power Supply / Slow-Start)	14.
SKD-BC200/500 Series	15.
BRUSHLESS SCREW COUNTER	
SKP-BC32HL-100(Counter / Power Supply / Slow-Start)	16.
BRUSHLESS DC-TYPE SCREWDRIVERS ALL SERIES	17.
MEDIUM TORQUE AC-TYPE AUTOMATIC TRIGGER AND PUSH START CLUTCH TYPE SERIES	
3 Series SK-3120L/P, SK-3220L/P, SK-3180L/P(LF/PF), SK-3280L/P(LF/PF)	18.
HIGH TORQUE AC-TYPE AUTOMATIC TRIGGER AND PUSH START CLUTCH TYPE SERIES	
8 Series SK-8130L/P(LF/PF), SK-8230L/P(LF/PF), SK-8140L/P(LF/PF), SK-8240L/P(LF/PF) SK-8150L/P, SK-8250L/P	19.
MEDIUM TORQUE AC-TYPE AUTOMATIC TRIGGER AND PUSH START CLUTCH TYPE SERIES	
9 Series SK-9131L/P(LF/PF), SK-9231L/P(LF/PF)	20.
HIGH TORQUE AC-TYPE AUTOMATIC TRIGGER AND PUSH START CLUTCH TYPE SERIES	
9 Series SK-9130L/P(LF/PF), SK-9230L/P(LF/PF), SK-9140L/P(LF/PF), SK-9240L/P(LF/PF) SK-9150L/P, SK-9250L/P	21.
POWER CONTROLLER	
SKP-32HL-60W, SKP-32VR-60W, SKP-32HL-2H	22.
LOW TORQUE DC-TYPE AUTOMATIC TRIGGER START CLUTCH TYPE SERIES	
2000 Series SKD-2000L, SKD-2200L, SKD-2300L	23.
MEDIUM TORQUE DC-TYPE AUTOMATIC TRIGGER START CLUTCH TYPE SERIES	
5000 Series SKD-5200L/P, SKD-5300L/P(LF/PF)	24.
7000 Series SKD-7000L/P, SKD-7200L/P, SKD-7800L/P(LF/PF)	25.
HIGH TORQUE DC-TYPE AUTOMATIC TRIGGER START CLUTCH TYPE SERIES	
8000 Series SKD-8300L/P(LF/PF), SKD-8400L/P, SKD-8500L/P	26.
VACUUM TYPE SCREWDRIVERS	
V2000 Series SKD-V2000LC, SKD-V2200LC, SKD-V2300LC	27.
SCREW COUNTER	
SKP-C32HL	28.
DC-TYPE SCREWDRIVERS (FOR SKP-C32HL ONLY)	
SKD-C2000/5000/7000/8000 Series	29.
LOW TORQUE AC-TYPE SEMI-AUTOMATIC TRIGGER START CLUTCH TYPE SERIES.	
2 Series SK-205LS, SK-2205LS, SK-215LS, SK-2215LS, SK-2125LS(LSF), SK-2225LS(LSF)	30.
MEDIUM & HIGH TORQUE AC-TYPE SEMI-AUTOMATIC TRIGGER START CLUTCH TYPE SERIES	
2 Series SK-2125LS(LSF), SK-2225LS(LSF), SK-2135LS, SK-2235LS, SK-2145LS, SK-2245LS	31.
TORQUE METERS	
KTM-10, KTM-100, KTM-50S, KTM-CSH, KTM-6	32.
IDLY ROTATING TORQUE SCREWDRIVER	
TD-1.5K, TD-3K, TD-6K, TD-12K, TD-20K, TD-30K, TD-50K, TD-100K	33.
SCREW FEEDER	
KFR-1050	34.
ACCESSORIES	
KP-AUXA, KP-AUX1T, KP-VAR, KP-VA1, KP-AUX2, KP-AUX5, KL-SS2, KL-SSB, KL-1, KL-2	35.
KH-1, KH-2, KH-3, KH-4, KH-5, KC-1, KC-2, KC-3, KC-4, KC-5, KC-6, KC-7, KC-9	36.
KW-1/3/4, PG-1/LG-2/LG-8/PG-8, KL-2000, KL-1200/KL-600, KB-1/2/3	37.

KILEWS INDUSTRIAL CO., LTD. was established in July 1984. The company began with USD\$3,000,000 investment and six staff. We created the KILEWS as our trademark with the most professional techniques for making automatic electric screwdrivers to the world.

In 1988, our investment grew to USD\$170,000 and we decided to expand international markets, especially for Asia region.

In 1990, based on increase demand in Korea market, KILEWS set up the electric screwdriver assembling plant in INCHON, KOREA.

In 1992, with the approval of Investment Commission, MOEA, the company invested US\$200,000 to TIANJIN TAIWEI INTERNATIONAL TRADING CO., LTD. For international trading and Northern China Customer Service Center of KILEWS.

In July 1994, KILEWS (CHINA) COUSTOMER SERVICE CENTER was established in SHEN-ZHEN, KUAN-CHOU of China and KILEWS (H.K.) TRADING COMPANY in December in Hong Kong.

In January 1995, KILEWS completed building a new plant in Hsin-Chuang City, Taipei, Taiwan, R.O.C., the capital was increased to USD\$350,000 at the same time with 46 staff through professional automatic equipment to sell our products to over the world.

In 1996, KILEWS established two China offices- TUNG-GUAN OFFICE in April and Central China Customer & Service Center, Shanghai in October.

In February 1997, KILEWS MARKETING (S.E.A) (SINGAPORE) was established to sell and provide service in South-Eastern Asia.

In January 1998, AC230V electric screwdriver has been approved the certification of CE from ITS. UK. which allowed KILEWS formally entering into the European markets. In June, acquired "the Chinese chang cheng Certification" to meet the demand of mainland China's widely market. In December, AC115V acquired UL approval to strengthen the competition and satisfy the American markets' demand.

KILEWS acquired three certifications in 1998- CE from ITS, UK. In January, Chinese Chang Cheng, China in June and UL of USA in December.

In April 1999, in order to satisfy increasing demand of EUROPE and UNITED STATES markets, the total capital has added to USD\$1,000,000 and increased the offshore staff at about 200 excluding 85 in Taiwan.

In August 2000, in order to further expand the Chinese market, KILEWS increased the capital to USD\$3,000,000 and established KILEWS Electric Tools (Shanghai) Co., Ltd. which manufacture electric screwdrivers for the needs of Chinese Market.

In September 2000, KILEWS acquired CE, UL & CUL certification on DC type 32V series electric screwdriver and Power Controller.

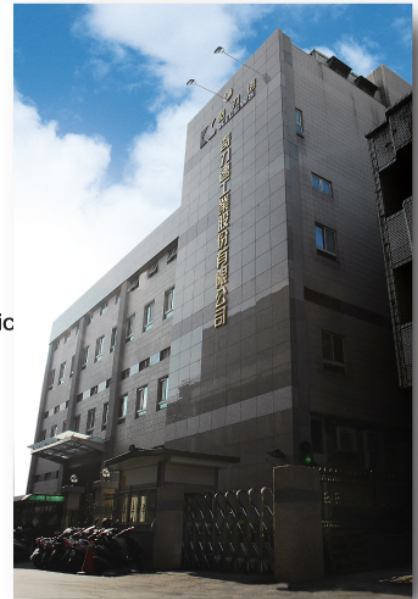

In December 2002, KILEWS Electric Tools (Shanghai) CO., LTD. was approved as ISO9001 manufacturer in China.

In January 2003, KILEWS' products passed and acquired the CCC certificates by China CQC.

In January 2005, KILEWS Electric Tools (VIETNAM) CO., Ltd. was set up in VIETNAM.

In October 2007, KILEWS new factory was set up in Taiwan and soon become one of biggest suppliers of electric screwdriver in the world.

In October 2008, the company held a grand opening of new plant in Taiwan for preparation of being a leading supplier of electric screwdrivers all over the world.



TABLE OF ALL MODELS

Page	Series	Screwdrivers						Power Model
		Model	Torque(kgf.cm)	Speed(r.p.m)	Screw Size(mm)	Features	Starting Method	
6	RB	SKD-RB75L/P	20~75	1000	4.0~5.0	Power Torque Brushless Screwdrivers	Trigger and Push Start	SKP-40B
		SKD-RB100L/P	30~100	800	5.0~6.0			
		SKD-RB120L/P	40~120	550	≤6			
		SKD-RB180L/P	60~180	350	≤8			
	TB	SKD-TB75L	20~75	1000	4.0~5.0			
		SKD-TB100L	30~100	800	5.0~6.0			
		SKD-TB120L	40~120	550	≤6			
		SKD-TB180L	60~180	350	≤8			
7	B800	SKD-B830L/P(LF/PF)	10~30(10~30)	1000(2000)	2.6~4.0(2.6~4.0)	Power Torque Screwdrivers with Counter	Trigger and Push Start	
		SKD-B850L/P	20~50	1000	4.5~5.0			
8	BE800	SKD-BE830(LF/PF)	10~30(10~30)	1000(2000)	2.6~4.0(2.6~4.0)	Medium/Low Torque Brushless Screwdrivers	Trigger Start	SKP-12HL
		SKD-BE850L/P	20~50	1000	4.5~5.0			
9	B100	SKD-B100L	0.08~1.5	1000/700	1.0~1.5	Medium/Low Torque Brushless Screwdrivers	Trigger Start	SKP-32B-60W
		SKD-B103L	0.5~3.5	1000/700	1.0~2.3			
10	B200	SKD-B203L	0.2~3.5	1000/700	1.0~2.3			
		SKD-B207L	0.5~7	1000/700	1.4~2.6			
10	B500	SKD-B210L	1~10	1000/700	1.6~3.0	Medium/Low Torque Screwdrivers with Counter	Trigger and Push Start	SKP-32B-60W SKP-BE32HL
		SKD-B512L/P(LF/PF)	1.5~12(2~12)	1000/700(2000)	1.6~3.0(1.6~3.0)			
		SKD-B517LF/PF	3~17	2000	2.3~3.5			
		SKD-B519L/P	3~19	1000/700	2.3~3.5			
11	BE500	SKD-BE512L/P(LF/PF)	1.5~12(2~12)	1000/700(2000)	1.6~3.0(1.6~3.0)			
		SKD-BE517LF/PF	3~17	2000	2.3~3.5			
		SKD-BE519L/P	3~19	1000/700	2.3~3.5			
		SK-3120L/P, SK-3220L/P	1.5~12	1000	1.6~3.0			
18	3	SK-3180L/P, SK-3280L/P	3~19	1000	2.6~3.5			
		SK-3180LF/PF, SK-3280LF/PF	1.5~12	2000	2.0~3.0			
19	8	SK-8130L/P(LF/PF)	5~22(5~17)	1000(1900)	2.6~4.0(2.3~4.0)	AC Automatic Screwdrivers	Trigger and Push Start	
		SK-8230L/P(LF/PF)	10~30(10~30)	700(1000)	3.0~5.0(3.0~5.0)			
		SK-8150L/P, SK-8250L/P	15~45	500	4.0~6.0			
		SK-9131L/P(LF/PF)	5~20(5~13)	1000(2000)	2.6~4.0(2.0~3.5)			
20 21	9	SK-9231L/P(LF/PF)	5~22(5~17)	1000(1900)	2.6~4.0(2.3~4.0)			
		SK-9130L/P(LF/PF)	10~30(10~30)	700(1000)	3.0~5.0(3.0~5.0)			
		SK-9240L/P(LF/PF)	15~45	500	4.0~6.0			
		SK-9150L/P, SK-9250L/P	0.2~3.5	1000/700	1.0~2.3			
23	2000	SKD-2000L	0.2~3.5	1000/700	1.0~2.3		Trigger Start	
		SKD-2200L	0.5~7	1000/700	1.4~2.6			
24	5000	SKD-2300L	1~10	670/470	1.6~3.0	DC Automatic Screwdrivers	Trigger and Push Start	SKP-32HL-60W SKP-32VR-60W SKP-32HL-2H
		SKD-5200L/P	1~12	1000/700	1.6~3.0			
25	7000	SKD-5300L/P(LF/PF)	3~16(1~8)	1000/700(2000)	2.3~3.5(1.6~3.0)			
		SKD-7000L/P	5~18	1000/700	2.0~3.5			
26	8000	SKD-7200L/P	7~24	750/520	2.6~4.0			
		SKD-7800L/P(LF/PF)	8~30(2~10)	530/350(2000)	3.0~5.0(2.0~3.0)			
27	V2000	SKD-8300L/P(LF/PF)	6~22(5~12)	1000/700(2000)	2.6~4.0(2.3~3.5)	Vacuum type Screwdrivers	Trigger Start	
		SKD-8400L/P	10~30	750/520	3.0~5.0			
30 31	2	SKD-8500L/P	15~45	530/350	4.0~6.0	AC Semi-Automatic Screwdrivers	Trigger Start	
		SKD-V2000LC	0.2~3.5	1000/700	1.0~2.3			
		SKD-V2200LC	0.5~7	1000/700	1.4~2.6			
		SKD-V2300LC	1~10	670/470	1.6~3.0			
		SK-205LS, SK-2205LS	0.5~7	1000	1.4~2.6			
		SK-215LS, SK-2215LS	2~15	1000	2.0~4.0			
		SK-2125LS(LSF)	5~25(5~18)	1000(2000)	2.6~4.0			
		SK-2225LS(LSF)	10~35	700	2.6~5.0			
		SK-2135LS, SK-2235LS	15~45	500	3.0~6.0			
		SK-2145LS, SK-2245LS						

TORQUE OF ALL MODELS (kgf.cm)

Series	Model	0.1	0.5	1	1.5	2	2.5	3	3.5	4	4.5	5	5.5	6	6.5	7	7.5	8	8.5	9	9.5	10	10.5	11	11.5	12	12.5	13	13.5	14	14.5	15	15.5	16	16.5	17	17.5	18	18.5	19	19.5	20	30	40	50	60	70	80	90	100	110	120	130	140	150	190	kgf.cm
RB	SKD-RB75L/P																					20-75																																			
	SKD-RB100L/P																					30-100																																			
	SKD-RB120L/P																					40-120																																			
	SKD-RB180L/P																					60-180																																			
TB	SKD-TB75L																					20-75																																			
	SKD-TB100L																					30-100																																			
	SKD-TB120L																					40-120																																			
	SKD-TB180L																					60-180																																			
B800	SKD-B830L/P(LF/PF)																					10-30(10-30)																																			
	SKD-B850L/P																					20-50																																			
BE800	SKD-BE830(LF/PF)																					10-30(10-30)																																			
	SKD-BE850L/P																					20-50																																			
B100	SKD-B100L	0.08-1.5																																																							
	SKD-B103L	0.5-3.5																																																							
B200	SKD-B203L	0.2-3.5																																																							
	SKD-B207L	0.5-7																																																							
B500	SKD-B210L	1-10																																																							
	SKD-B512L/P(LF/PF)	1.5-12(2-12)																																																							
B500	SKD-B517LF/PF	3-17																																																							
	SKD-B519L/P	3-19																																																							
BE500	SKD-BE512L/P(LF/PF)	1.5-12(1.5-12)																																																							
	SKD-BE517LF/PF	3-17																																																							
BE500	SKD-BE519L/P	3-19																																																							
	SK-3120L/P, SK-3220L/P	1.5-12																																																							
3	SK-3180L/P, SK-3280L/P	3-19																																																							
	SK-3180LF/PF, SK-3280LF/PF	1.5-12																																																							
8	SK-8130L/P, SK-8230L/P	5-22																																																							
	SK-8130LF/PF, SK-8230LF/PF	5-17																																																							
	SK-8140L/P, SK-8240L/P	10-30																																																							
	SK-8140LF/PF, SK-8240LF/PF	10-30																																																							
9	SK-8150L/P, SK-8250L/P	15-45																																																							
	SK-9131L/P, SK-9231L/P	5-20																																																							
	SK-9131LF/PF, SK-9231LF/PF	5-13																																																							
	SK-9130L/P, SK-9230L/P	5-22																																																							
2000	SK-9130LF/PF, SK-9230LF/PF	5-17																																																							
	SK-9140L/P, SK-9240L/P	10-30																																																							
	SK-9140LF/PF, SK-9240LF/PF	10-30																																																							
	SK-9150L/P, SK-9250L/P	15-45																																																							
5000	SKD-2000L	0.2-3.5																																																							
	SKD-2200L	0.5-7																																																							
	SKD-2300L	1-10																																																							
7000	SKD-5200L/P	1-12(2-12)																																																							
	SKD-5300L/P(LF/PF)	1-8(LF/PF)																				3-16																																			
8000	SKD-7000L/P	5-18																																																							
	SKD-7200L/P	7-24																																																							
8000	SKD-7800L/P(LF/PF)	2-10(LF/PF)																				8-30																																			
	SKD-8300L/P(LF/PF)	5-12(LF/PF)																				6-22																																			
V2000	SKD-8400L/P	10-30																																																							
	SKD-8500L/P	15-45																																																							
2	SKD-V2000LC	0.2-3.5																																																							
	SKD-V2200LC	0.5-7																																																							
	SKD-V2300LC	1-10																																																							
2	SK-205LS, SK-2205LS	0.5-7																																																							
	SK-215LS, SK-2215LS	2-15																																																							
	SK-2125LS, SK-2225LS	5-25																																																							
	SK-2125LSF, SK-2225LSF	5-18																																																							
	SK-2135LS, SK-2235LS	10-35																																																							
	SK-2145LS, SK-2245LS	15-45																																																							

(1 kgf.cm=0.098N.m, 1 kgf.cm=0.885 Lbf.in, 1 N.m=10.2kgf.cm)







SCREWDRIVERS MODEL RECOGNIZE DESCRIPTION

DC-TYPE(BRUSHLESS SERIES)
DC-TYPE(CARBON BRUSH SERIES)
AC-TYPA(CARBON BRUSH SERIES)

DC-TYPE(BRUSHLESS SERIES)



S K D - B 5 1 9 P F D

↓ ↓ ↓ ↓ ↓
1 2 6 7 8

- Post 1-DC-TYPE
- Post 2-B: Brushless Electric Screwdrivers Series
- Post 6-Start Type: "P"-Push Start Type; "L"-Trigger Start Type
- Post 7-"F"- High Speed Type
- Post 8-Bit Type
 - "A"-Bit in SS 5mm, Hexagon Type 
 - "B"-Bit in SS 6.35mm, Hexagon Type 
 - "C"-Bit in M3 4Ø Round Type 
 - "D"-Bit in M6 5Ø Round Type 





S K D - R B 7 5 P
S K D - T B 7 5 L U W

↓ ↓ ↓ ↓ ↓
1 2 5 6 7

- Post 1-DC-TYPE
- Post 2-RB: Power Torque(Brushless)in-line Type
Operation(RB Type must be used with Auxiliary Arm together)
- TB: Power Torque(Brushless) T-Type Operation
- Post 5-Start Type: "P"-Push Start Type; "L"-Trigger Start Type
- Post 6-Power Source Input Way
 - "U"-Top-cord
 - "D"-Bottom-cord
- Post 7-Bit Type
 - "B"-Bit in SS 6.35mm, Hexagon Type 
 - "W"-Round-Socket Drive 

S K D - B E 5 1 9 P F D





↓ ↓ ↓ ↓ ↓
1 2 3 7 8 9

- Post 1-DC-TYPE
- Post 2-B: Brushless Electric Screwdrivers Series
- Post 3-E :Counter and electric screwdriver are one compact
- Post 7-Start Type: "P"-Push Start Type; "L"-Trigger Start Type
- Post 8-"F"- High Speed Type
- Post 9-Bit Type
 - "A"-Bit in SS 5mm, Hexagon Type 
 - "B"-Bit in SS 6.35mm, Hexagon Type 
 - "C"-Bit in M3 4Ø Round Type 
 - "D"-Bit in M6 5Ø Round Type 

DC-TYPE(CARBON BRUSH SERIES)

S K D - 5 3 0 0 L F D





↓ ↓ ↓ ↓
1 6 7 8

- Post 1-DC-TYPE
- Post 6-Start Type: "P"-Push Start Type; "L"-Trigger Start Type
- Post 7-"F"-High Speed Type
- Post 8-Bit Type
 - "A"-Bit in SS 5mm, Hexagon Type 
 - "B"-Bit in SS 6.35mm, Hexagon Type 
 - "C"-Bit in M3 4Ø Round Type 
 - "D"-Bit in M6 5Ø Round Type 

AC-TYPE(CARBON BRUSH SERIES)

S K - 9 2 3 0 P F A

↓ ↓ ↓ ↓ ↓
1 3 6 7 8

- Post 1-AC-TYPE
- Post 3-Input Voltage: "1"-AC110~120Volt 50/60Hz
"2"-AC220~240Volt 50/60Hz
- Post 6-Start Type: "P"-Push Start Type; "L"-Trigger Start Type
- Post 7-"F"- High Speed Type
- Post 8-Bit Type
 - "A"-Bit in SS 5mm, Hexagon Type 
 - "B"-Bit in SS 6.35mm, Hexagon Type 
 - "C"-Bit in M3 4Ø Round Type 
 - "D"-Bit in M6 5Ø Round Type 



BRUSHLESS SCREWDRIVERS POWER CONTROLLER

SKP Series 【SKP-32B-60W, SKP-BE32HL, SKP-40B】



External Dimension

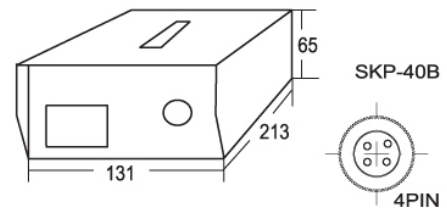
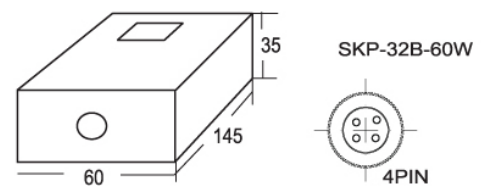
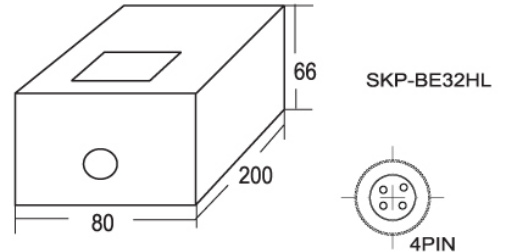

SKP-32B-60W, SKP-BE32HL, SKP-40B

- Input voltage : AC 100V~240V by AC power source.
Output voltage : DC24V/DC32V for SKP-32B-60W and SKP-BE32HL
Output voltage : DC40V for SKP-40B
- Power switch : Small volume, light weight , easy to use, stable power source output.
- All controllers have the power source light indicator. Green light indicates normal. Red light indicates overload.

Specifications

Model	SKP-32B-60W	SKP-BE32HL	SKP-40B
Input Voltage	AC100-240V 50/60Hz	AC100-240V 50/60Hz	AC100-240V 50/60Hz
Output Voltage	LO DC24V/HI DC32V	LO DC24V/HI DC32V	DC40V
Capacity	1.8A MAX	1.8A MAX	5.5A
Outside Dimensions	145X60X35(mm)	200X80X66(mm)	213X131X65(mm)
Weight(g)	250(main body)	460(main body)	1800(main body)
AC Cord Length	2M with ground	2M with ground	2M with ground
Suitable Model	SKD-B512L SKD-B512P SKD-B519L SKD-B519P SKD-BE512L SKD-BE512P SKD-BE519L SKD-BE519P SKD-B203L SKD-B207L SKD-B210L	SKD-B512LF SKD-B512PF SKD-B517LF SKD-B517PF SKD-BE512LF SKD-BE512PF SKD-BE517LF SKD-BE517PF SKD-BE519L SKD-BE519P	SKD-B830L SKD-B830P SKD-B850L SKD-B850P SKD-B830LF SKD-B830PF SKD-BE830L SKD-BE830P SKD-BE850L SKD-BE850P SKD-BE830LF SKD-BE830PF SKD-RB Series SKD-TB Series
ESD(Anti-Static)	✓	✓	✓
UL(CUL)ETL	✓	✓	✓
CE	✓	✓	✓
RoHS	✓	✓	✓
Remark			

Plug Feature

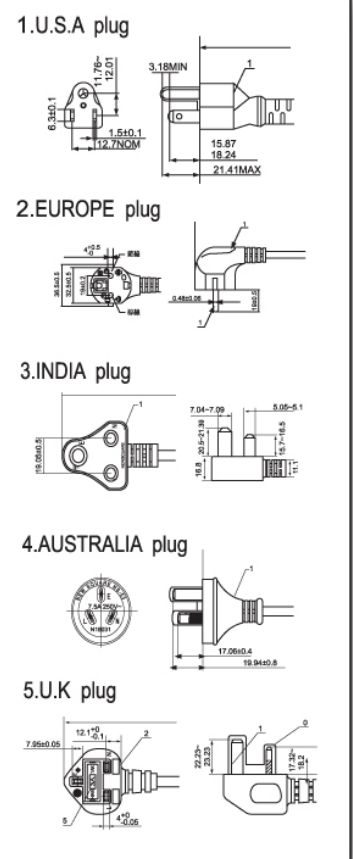



- Whole series use brushless motor, no carbon pollution, low noise motor operation, It is the best fit for assembling high torque products.
- Assemble large-sized LED/LCD panel and home appliances, Tools can be hanged with spring balancer to lessen work fatigue.
- TB and RB torque ranges is from 2 to 18N.m, stable torque output with great precision can replace pneumatic screwdrivers—unstable torque, grease-polluted and noise-polluted.
- RB type must be collaborated with Auxiliary Arm which can increase stable torque output, torque precision, and easier to operate, RB type series are most applied to assemble large products on automatic production line.
- Highly mobile, easy to operate, stable torque, high efficiency. Motor can be free from fatigue under long-working hours.

Accessories

Power Controller



Spring Balancer KL-2000



External Dimension

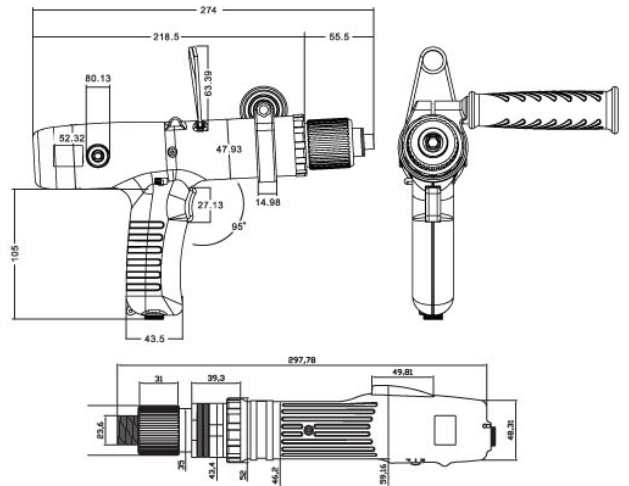

Torque Range Chart

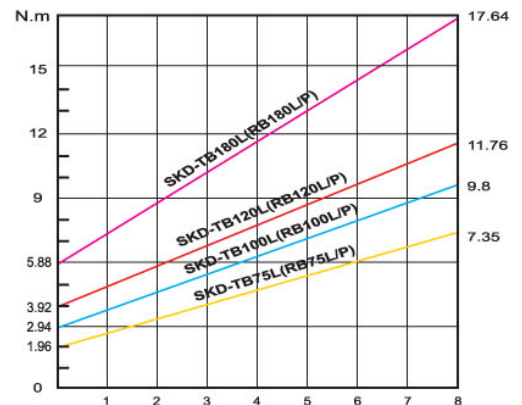

Specifications

Model	SKD-RB75L SKD-RB75P	SKD-RB100L SKD-RB100P	SKD-RB120L SKD-RB120P	SKD-RB180L SKD-RB180P	SKD-TB75L	SKD-TB100L	SKD-TB120L	SKD-TB180L	
Input Voltage	DC40V								
Power Consumption	100W	120W	120W	200W	100W	120W	120W	200W	
Torque	(kgf.cm)	20~75	30~100	40~120	60~180	20~75	30~100	40~120	60~180
	(Lbf.in)	17.4~65.1	20.04~86.8	34.7~104.16	52.1~156.24	17.4~65.1	20.04~86.8	34.7~104.16	52.1~156.24
	(N.m)	1.96~7.35	2.94~9.8	3.92~11.76	5.88~17.64	1.96~7.35	2.94~9.8	3.92~11.76	5.88~17.64
Repeatable Torque Accuracy(%)	±5%								
Torque Adjustment	Stepless								
Free Speed(r.p.m)	1000	800	550	350	1000	800	550	350	
Screw Size Dia (mm)	Machine Screw	4.0~5.0	5.0~6.0	≤6	≤8	4.0~5.0	5.0~6.0	≤6	≤8
	Tapping Screw	≤4	≤4.5	≤5	≤6	≤4	≤4.5	≤5	≤6
Weight(kg)	1.20			1.25					
Length(mm)	298			274X160					
ESD(Anti-Static)	✓			✓					
CE	✓			✓					
RoHS	✓			✓					
Auxiliary Arm	KP-AuxA			-					
Handle Grip	CF85002			CF85002					
Bit Type	 HEX 6.35mm(No.3)				 3/8"sq				

Auxiliary Arm



BRUSHLESS POWER TORQUE DC-TYPE AUTOMATIC TRIGGER AND PUSH START CLUTCH TYPE SERIES(High Torque-High Speed)
SKD-B800 Series 【SKD-B830L, SKD-B850L, SKD-B830LF】
 【SKD-B830P, SKD-B850P, SKD-B830PF】



SKD-B830L/P, SKD-B850L/P, SKD-B830LF/PF

- Brushless feature is applicable in a dust-free condition. The output of torque is highly stable. It is not only a easy-operate equipment but this screwdriver can be operated for a long period.
- The screwdriver has a LED light which is able to remind the operators that the power is supplying.
- The series of SKD-B800 has two rotation rates selection: 1,000r.p.m / 2,000r.p.m. The range of th torque could be reach to 10-50kgf.cm.
- Besides, it is a toner-free and noise-free equipment and Low voltage DC40V is also applied. There are variable torque's ranges can be selected: 30kgf.cm/2000r.p.m, 30kgf.cm/1000r.p.m, and 50kgf.cm/1000r.p.m.
- The best choice when composing the vertical's internal parts and/or any large-size electric equipments, including home appliances, LED/LCD panels and etc.
- Optional accessories spring balancer hoist or pistol grip can be added for easy and safe operation.

External Dimension

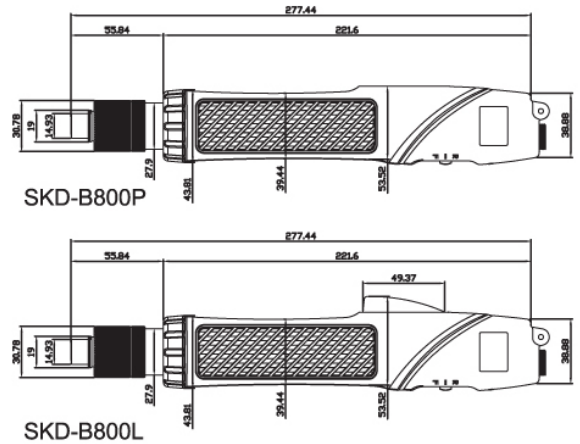

Torque Range Chart

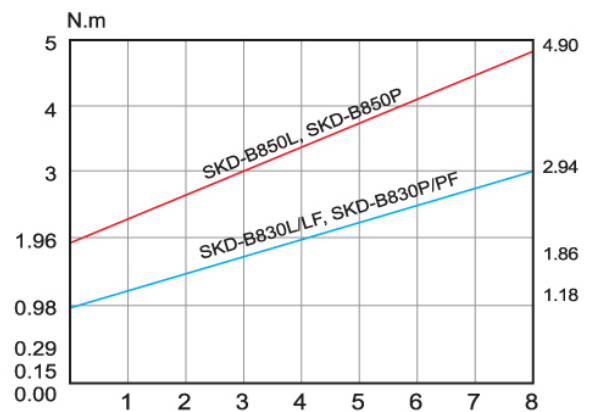

Specifications

Model		SKD-B830L	SKD-B830P	SKD-B830LF	SKD-B830PF	SKD-B850L	SKD-B850P
Input Voltage		DC40V					
Power Consumption		90W	90W	90W	90W	120W	120W
Torque	(kgf.cm)	10~30	10~30	10~30	10~30	20~50	20~50
	(Lbf.in)	8.86~26.04	8.86~26.04	8.86~26.04	8.86~26.04	17.36~43.40	17.36~43.40
	(N.m)	0.98~2.94	0.98~2.94	0.98~2.94	0.98~2.94	1.96~4.90	1.96~4.90
Repeatable Torque Accuracy(%)		±3%					
Torque Adjustment		Stepless					
Free Speed (r.p.m)	HI	1000	1000	2000	2000	1000	1000
	LO	-	-	-	-	-	-
Screw Size Dia (mm)	Machine Screw	2.6~4.0	2.6~4.0	2.6~4.0	2.6~4.0	4.0~5.0	4.0~5.0
	Tapping Screw	2.6~3.5	2.6~3.5	2.6~3.5	2.6~3.5	≤4	≤4
Weight(g)		800					
Length(mm)		278					
ESD(Anti-Static)		✓					
CE		✓					
RoHS		✓					
Bit Type							

Accessories

Torque Fixing Ring KC-7C 	Torque Adjuster KW-1
Suspension Rack KH-2 	90° Degree Attachment KL-1 (only "L" type)
KL-1200 Spring Balancer 	Pistol Grip LG-8, PG-8
Power Controller SKP-40B 	

FIRST SMALLEST BRUSHLESS DC-12V SCREWDRIVERS IN THE WORLD MINI LOW TORQUE SERIES SKD-B100 Series 【SKD-B100L, SKD-B103L】



External Dimension

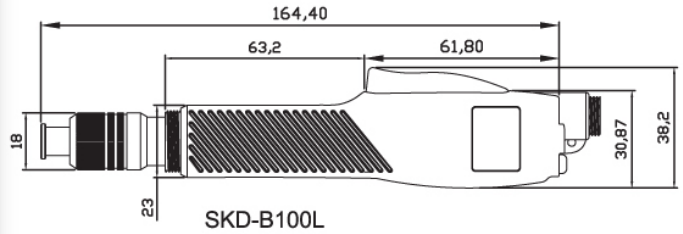

Torque Range Chart

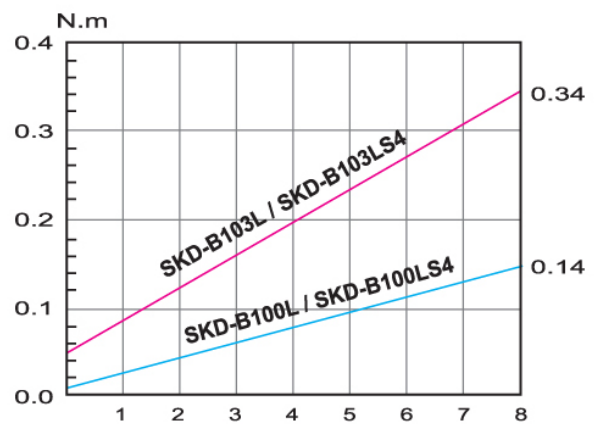

SKD-B100L, SKD-B103L

- Adopting the high function of innovation and brushless feature. Durable and permanent life-time. Maintenance is unnecessary.
- Small and light weight, noiseless, streamlined appearance, high stability and easy to use.
- First creation of the most smallest and lightest brushless feature.
- First innovation of Forward/Reverse switch modes ever. Screws can be loosened easily just in a moment without switching the switches' modes.
- Two lowest torque specifications: 0.08~1.5Kgf.cm / 0.5~3.5Kgf.cm. Best choice for producing high precision products, such as watches, high precision hard-driver and etc.
- 1000rpm / 700rpm rotation rates; directly switching from power source.
- Certification: ETL and CE
- Anti-static electricity selections on the Cover Housing.

Specifications

Model		SKD-B100L	SKD-B103L	SKD-B100LS4	SKD-B103LS4
Input Voltage		DC12V			
Torque	(kgf.cm)	0.08~1.5	0.5~3.5	0.08~1.5	0.5~3.5
	(Lbf.in)	0.07~1.32	0.44~3.08	0.07~1.32	0.44~3.08
	(N.m)	0.008~0.14	0.05~0.343	0.008~0.14	0.05~0.343
Repeatable Torque Accuracy(%)		±5%			
Torque Adjustment		Stepless			
Free Speed (r.p.m)	HI	1000	1000	280	280
	LO	700	700	200	200
Screw Size Dia (mm)	Machine Screw	1.0~1.7	1.0~2.3	1.0~1.7	1.0~2.3
	Tapping Screw	1.0~1.5	1.0~2.0	1.0~1.5	1.0~2.0
Weight(g)		170			
Length(mm)		165			
Power Controller		SKP-12HL			
Bit Type					



Power Controller Specification

Model	SKP-12HL
Input Voltage	AC100~240V 50/60Hz
Output Voltage	Lo DC9V Hi DC12V
Capacity	2.5A
Size	105X52X31
Weight	0.14kg
Cord Length	2M

Accessories





SKD-B203L
SKD-B207L
SKD-B210L

SKD-B512L/P
SKD-B512LF/PF
SKD-B517LF/PF
SKD-B519L/P

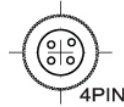

SKD-B203L, SKD-B207L, SKD-B210L, SKD-B517LF/PF
SKD-B512L/P, SKD-B519L/P, SKD-B512LF/PF

- Adopts High-Functional Brushless Motor, marvelous lifespan and strong durability to repair and maintenance almost needless.
- Smaller size, light weight, low noise-pollution, fashionable design, high stability and easy operation motor which gives the benefit of longer working-time. (3 years warranty)
- Brushless Motor has more stable torque output : It is best to fit for operating in clean-room circumstance and no worry of pollution will be arisen.
- Best tool to assemble Watch, Laptop, Digital Camera, DVD Player, Cell Phone, Communication Equipment and High tech Products which need to be assembled in clean-room.
- The screwdrivers have two speed selections can be changed to Hi and Lo(High speed screwdrivers model except), stable R.P.M.

External Dimension

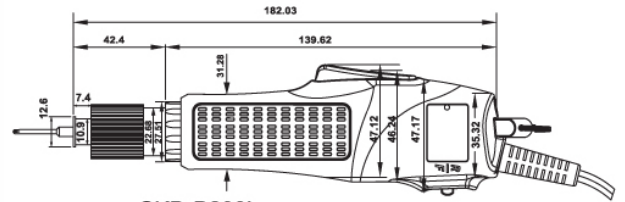

SKD-B200L

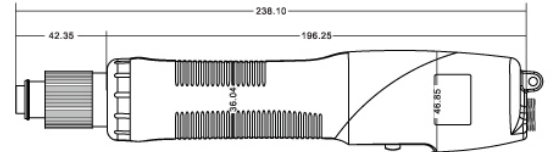

SKD-B500P

Accessories

Torque Fixing Ring
KC-6C(B500 Series)
KC-4C(B200 Series)



Torque Adjuster
KW-3(B500 Series)
KW-4(B200 Series)



Power Controller
SKP-BE32HL
(LF/PF Use Only)



Suspension Rack
KH-4(B500 Series)
KH-5(B200 Series)



90° Degree Attachment
KL-2(B500L Series)

KL-1200
(B500 Series)



KL-600
(B200 Series)
Spring Balancer

Specifications

Model		SKD-B203L	SKD-B203LS5	SKD-B203LS6	SKD-B203LS7	SKD-B207L	SKD-B210L	SKD-B512L/P	SKD-B512LF/PF	SKD-B517LF/PF	SKD-B519L/P
Input Voltage		DC24V or DC32V									
Power Consumption		25W						55W			
Torque	(kgf.cm)	0.2~3.5	0.2~3.5	0.2~3.5	0.2~3.5	0.5~7	1~10	L 1.5~12 P 2~12	L 1.5~12 P 2~12	3~17	3~19
	(Lbf.in)	0.17~3.05	0.17~3.05	0.17~3.05	0.17~3.05	0.44~6.16	0.87~8.7	L 1.32~10.56 P 1.76~10.56	L 1.32~10.56 P 1.76~10.56	2.64~14.76	2.64~16.72
	(N.m)	0.02~0.34	0.02~0.34	0.02~0.34	0.02~0.34	0.05~0.69	0.10~0.98	L 0.15~1.18 P 0.19~1.18	L 0.15~1.18 P 0.19~1.18	0.29~1.67	0.29~1.86
Repeatable Torque Accuracy(%)		±3%									
Torque Adjustment		Stepless									
Free Speed (r.p.m)	HI	1000	500	370	230	1000	1000	1000	2000	2000	1000
	LO	700	350	260	160	700	700	700	-	-	700
Screw Size Dia (mm)	Machine Screw	1.0~2.3	1.0~2.3	1.0~2.3	1.0~2.3	1.4~2.6	1.6~3.0	1.6~3.0	1.6~3.0	1.6~3.0	2.3~3.5
	Tapping Screw	1.0~2.0	1.0~2.0	1.0~2.0	1.0~2.0	1.4~2.3	1.6~2.6	1.6~2.6	1.6~2.6	1.6~2.6	2.3~3.0
Weight(g)		385						520			
Length(mm)		185						245			
ESD(Anti-Static)		✓									
CE		✓									
RoHS		✓									
Bit Type											



INTELLIGENT MULTI-FUNCTION UNIT FOR HIGH TORQUE

In order to achieve accurate counting on screw fastening and work together with PLC based process control, we integrate screw counter and power supply function into unique device which is both power supply and screw counter as well. SKP-BC40HL is designed more conveniently and perfectly to meet users' practicability and availability.

EXTERNAL DIMENSION

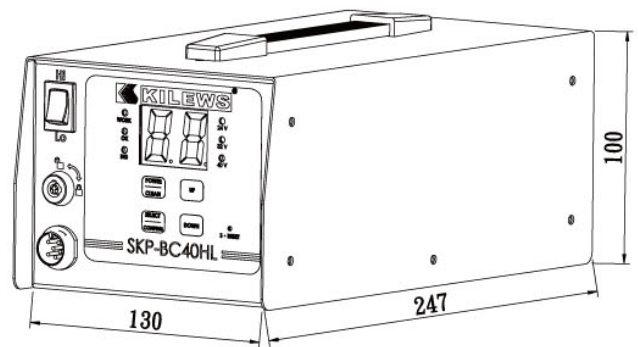

Features

- Auto detect missing screw, screw stripped, floating lock and wrong choosing of screw
- With dual-locking function to avoid wrong operation and adjustment.
- Selectable between auto-reset or manual reset.
- Suitable for operation in the clean room.
- The most complete function system such as the setting for SL, SC, RC, SP, AT, LT, HT, LL, This is the most professional design and choice.
- Slow-start function which is able to set slow-start time and rotation speed level from L0-L9 to control the screwdriver start from low speed to normal rotation speed.
- Auto-Learning function, to measure the time for screw fastening, is convenient when the users simulate the time of the screw fastening for the special screws.
- Can store five sets of data memory. The users can choose single set to operate or five sets to operate cyclically like as one screwdriver used as 5 in 1. It's the best choice of screws counter.
- Displaying the quantity of unfinished or fastened screws, and the users can add external sensor switch to avoid any mistake from shortage of screw fastening. SKP-BC40HL is able to prompt user automatically while the fastening job is done as setting. Screw counting is also able to connect external devices.
- Setting output input signal (Open Collector) such function is suitable for semi or full automatic. Production line and function for contact point of relay, to prevent operator from improper operation. And make an accurate calculation by signal of sensor.
- Applicable to automatic/semi-automatic production line, which can effectively prevent the operators improper operation, and through the sensor signal can be precisely Foolproof.
- Enable to connect with external PLC system to make production line humanistic. Calculate the screws numbers which must be fastened by computer to avoid any unnecessary neglect of screw fastening.
- This system provides +12V DC which can connect to CN1(V+) and CN5(COM) to use the voltage if the users need and then connect to PLC.
- SKP-BC40HL can detect the voltage of the screwdrivers automatically and supply to them. SKP-BC40HL is suitable for Kilews brushless screwdrivers, include BC200 Series, BC500 Series, BC800 Series, and TBC / RBC series.
- Prevent the screw fastening mistake. SKP-BC40HL can connect the sensor to detect the mistake when the screws fastening, then force to shut-down and show warning message.

BRUSHLESS DC-TYPE SCREWDRIVERS

SKP-BC40HL Specification



Specifications

Model	SKP-BC40HL	
Input Voltage	AC 100~240V 50/60HZ	
Output Voltage	DC 40V/32V/24V 5.5A/6.9A/9.2A	
PowerConsumption	220W	
Count	1~99	
Count method	Count-up/Count-down	
Work with Sensor	ON/OFF	
GATE Sensor	ON(2 Sensor)/OFF(1 Sensor)	
Slow-start time adjustable	0~9.9 seconds	
Slow-start speed adjustable	35%~85% L0~L9 Rated speed	
Running Time limit-LO	0.00~9.99 seconds	
Running Time limit-HI	0.0~9.9 seconds	
NG alarm	On/Off/FF/EF with LED and buzzer	
OK alarm	On/Off/FF/EF with LED and buzzer	
Auto ZERO	ON/OFF	
External inputs	Sensor/Reset	
External outputs	OK/NG/OK ALL	
Screwdriver Control	Speed : HI/LO (SLOWSTART)	
Dimensions(mm)	247X130X100	
Weight(Kg)	2.4	
Applicable Models	SKD-BC203L SKD-BC207L SKD-BC210L	
	SKD-BC512L, SKD-BC512P SKD-BC512LF, SKD-BC512PF SKD-BC519L, SKD-BC519P SKD-BC517LF, SKD-BC517PF	
	SKD-BC830L, SKD-BC830P SKD-BC830LF, SKD-BC830PF SKD-BC850L, SKD-BC850P	
	SKD-TBC75L, SKD-TBC100L SKD-TBC120L, SKD-TBC180L	
Applicable Models	SKD-RBC75L, SKD-RBC75P SKD-RBC100L, SKD-RBC100P SKD-RBC120L, SKD-RBC120P SKD-RBC180L, SKD-RBC180P	
	Accessories	Power cordX1、KeyX2



(Not apply for SKD-B100)



External Dimension

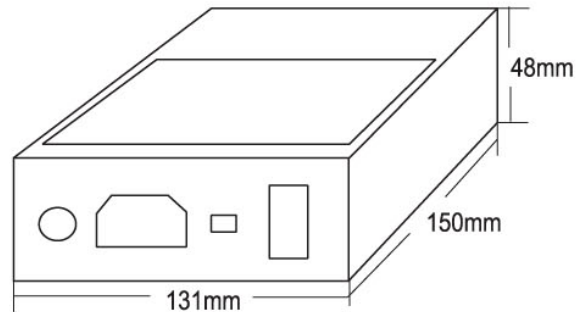

In order to receive accurate counting on screw fastening and work together with PLC based process control system for electric screwdrivers, we integrate screw counter and power supply function into unique one device which is a power supply itself and a screw counter as one combine. The model number SKP-BC32HL Screw Counter has taken into consideration of practicability and availability for user to operate more conveniently.

SKP-BC32HL adds an Auto-Learning Function which allows user to operate it under the circumstance of unknown screw length and electric screwdrivers rotation speed, or user needs to fasten screws with slow- start function at the same time, SKP-BC32HL includes an auto-learning function which ables the. Screw Counter to determine the best setting value for your screw fastening job.

Features

- Slow-Start function is able to set rotation speed and timing, it allows electric screwdriver to start under very low speed and gradually returns at normal speed.
- Selectable auto-reset retrieval or manual reset retrieval for setting up screw count.
- SKP-BC32HL enhances the auto-identified screw fastening time mode, allow user to aim at simulating the duration of specific screw fastening.
- Displaying the number of unfinished screw counts, user can add external sensor switch to prevent any operation error from neglect when fastening screws, Buzzer sounds automatically notify user while fastening job is done as screw setting number. Internal signal for detecting screw count is also able to connect external devices.
- SKP-BC32HL is capable of equipping with output and input signal, such function is suitable for semi or full automatic production line to keep operator from improper operation and make an accurate calculation through the signal of sensor.
- Enable to connect with external PLC system to streamline production line. Calculate the screw numbers to be fastened by computer to avoid any unnecessary neglect of screw fastening.
- SKP-BC32HL provides with +32V/+20V of DC voltage, if user requires such power source, it can be connected to V+(+) and COM(-), and then connect to PLC.
- Input Voltage range from AC100V to 240V.

Specifications

Model	SKP-BC32HL
Input Voltage	AC100V~240V 50/60Hz
Output Voltage	DC32V/20V 1.8A/3A
Count	1~99
Count method	Count-up/Count-down
Work with Sensor	ON/OFF
GATE Sensor	ON(2 Sensor)/OFF(1 Sensor)
Slow-start time adjustable	0~9.9 seconds
Slow-start speed adjustable	30%~100% L0~L9 Rated Speed
Running Time limit-LO	0.00~9.99 seconds
Running Time limit-HI	0.0~9.9 seconds
NG alarm	On/Off/FF/EF with LED and buzzer
OK alarm	On/Off/FF/EF with LED and buzzer
Auto ZERO	ON/OFF
External inputs	Sensor/Reset
External outputs	OK/NG/OK all
Screwdriver Control	SPEED : HI/LO (SLOW START)
Outside Dimensions	150X48X130(mm)
Accessories	Power cordX1 Suspension bailX2 Terminal BlockX1
Remark	

BRUSHLESS DC-TYPE SCREWDRIVERS

SKD-BC Series 【SKD-BC203L/207L/210L】

【SKD-BC512L/519L, SKD-BC512P/519P】



Specifications

Model		SKD-BC203L	SKD-BC207L	SKD-BC210L
Torque	(kgf.cm)	0.2~3.5	0.5~7	1~10
	(Lbf.in)	0.17~3.05	0.44~6.16	0.87~8.7
	(N.m)	0.02~0.34	0.05~0.69	0.10~0.98
Specifications Speed (r.p.m)±10%	HI	1000	1000	1000
	LO	700	700	700
Screw Size Dia (mm)	Machine Screw	1.0~2.3	1.4~2.6	1.6~3.0
	Tapping Screw	1.0~2.0	1.4~2.3	1.6~2.6
Weight(g)		385	385	385
Length(mm)		185	185	185



Specifications

Model		SKD-BC512L	SKD-BC519L
Torque	(kgf.cm)	1.5~12	3~19
	(Lbf.in)	1.32~10.56	2.64~16.72
	(N.m)	0.15~1.18	0.29~1.86
Specifications Speed (r.p.m)±10%	HI	1000	1000
	LO	700	700
Screw Size Dia (mm)	Machine Screw	1.6~3.0	2.3~3.5
	Tapping Screw	1.6~2.6	2.3~3.0
Weight(g)		520	520
Length(mm)		245	245



Specifications

Model		SKD-BC512P	SKD-BC519P
Torque	(kgf.cm)	2~12	3~19
	(Lbf.in)	1.76~10.56	2.64~16.72
	(N.m)	0.19~1.18	0.29~1.86
Specifications Speed (r.p.m)±10%	HI	1000	1000
	LO	650	650
Screw Size Dia (mm)	Machine Screw	1.6~3.0	2.3~3.5
	Tapping Screw	1.6~2.6	2.3~3.0
Weight(g)		520	520
Length(mm)		245	245





EXTERNAL DIMENSION

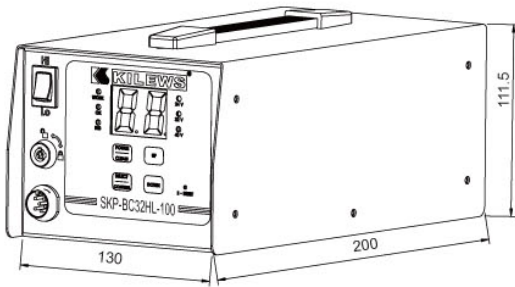

Specifications

Model	SKD-BC512LF	SKD-BC512PF	SKD-BC517LF	SKD-BC517PF
Torque	(kgf.cm)	1.5~12	2~12	3~17
	(Lbf.in)	1.32~10.56	1.76~10.56	2.64~14.76
	(N.m)	0.15~1.18	0.19~1.18	0.29~1.67
Specifications Speed (r.p.m)±10%	HI	2000	2000	2000
	LO	--	--	-
Screw Size Dia (mm)	Machine Screw	1.6~3.0	1.6~3.0	1.6~3.0
	Tapping Screw	1.6~2.6	1.6~2.6	1.6~2.6
Weight(g)	520	520	520	520
Length(mm)	245	245	245	245

Specifications

Model	SKP-BC32HL-100
Input Voltage	AC100V~240V 50/60Hz
Output Voltage	DC32V/20V/3A
Output Watt	96W
Count	1~99
Count method	Count-up/Count-down
Work with Sensor	ON/OFF
GATE Sensor	ON(2 Sensor)/OFF(1 Sensor)
Slow-start time adjustable	0.1~9.9 seconds
Slow-start speed adjustable	35%~85% L0~L9 Rated Speed
Running Time limit-LO	0.01~9.99 seconds
Running Time limit-HI	0.1~9.9 seconds
NG alarm	On/Off/FF/EF with LED and buzzer
Auto ZERO	ON/OFF
External inputs	Sensor/Reset
External outputs	OK/NG/OK all
Screwdriver Control	SPEED:HI/LO : SLOW START
Outside Dimensions	200X130X111.5(mm)
Accessories	Power cordX1、KeyX2
Applicable Models	SKD-BC512LF, SKD-BC512PF SKD-BC517LF, SKD-BC517PF

Features

- Slow-Start function is able to set rotation speed and timing, it allows electric screwdriver to start under very low speed and stop at normal speed.
- Selectable auto-reset retrieval or manual reset retrieval for setting up screw count.
- SKP-BC32HL-100 enhances the auto-identified screw fastening time mode, allow user to aim at simulating the duration of specific screw fastening.
- Displaying the number of unfinished screw counts, user can add external sensor switch to prevent any operation error from neglect when fastening screws, Buzzer sounds automatically to notify user while fastening job is done as screw setting number. Internal signal for detecting screw count is also able to connect external devices.
- SKP-BC32HL-100 is capable of equipping with output and input signal, such function is suitable for semi or full automatic production line to keep operator from improper operation and make an accurate calculation through the signal of sensor.
- Enable to connect with external PLC system to streamline production line. Calculate the screws numbers to be fastened by computer to avoid any unnecessary neglect of screw fastening.
- Input Voltage range from AC100V to 240V.

SKD-BC203L
 SKD-BC207L
 SKD-BC210L
 SKD-BC512L
 SKD-BC512P
 SKD-BC519L
 SKD-BC519P



SKD-BC512LF
 SKD-BC512PF
 SKD-BC517LF
 SKD-BC517PF



SKD-BC830L
 SKD-BC830P
 SKD-BC830LF
 SKD-BC830PF
 SKD-BC850L
 SKD-BC850P
 SKD-TBC50L
 SKD-TBC75L
 SKD-TBC100L
 SKD-TBC150L
 SKD-RBC50L
 SKD-RBC50P
 SKD-RBC75L
 SKD-RBC75P
 SKD-RBC100L
 SKD-RBC100P
 SKD-RBC150L
 SKD-RBC150P





SK-3120L, SK-3180L, SK-3220L, SK-3280L
SK-3120P, SK-3180P, SK-3220P, SK-3280P

- Extra strong magnet.
- Fatigue-resistant for long time using, torque accuracy $\pm 3\%$
- Compact, light-weight, and easy to operate, improve production efficiency.
- Best fit for Laptop and peripherals operation.
- Torque fixable with a fixing ring (KC-6)
- ※ Conform to EMI, EMC International Safety Standards.

External Dimension

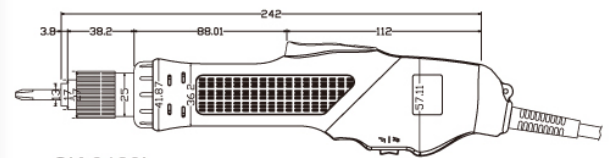

SK-3120L

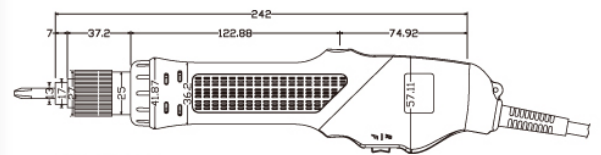

SK-3120P

Torque Range Chart

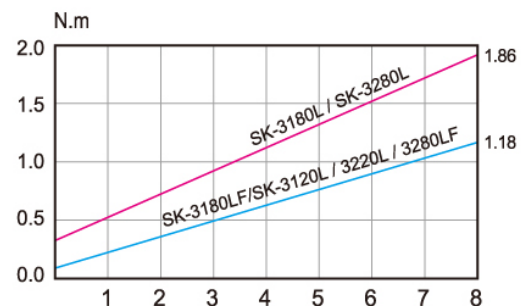

Specifications

Model		SK-3120L SK-3120P	SK-3180L SK-3180P	SK-3180LF SK-3180PF	SK-3220L SK-3220P	SK-3280L SK-3280P	SK-3280LF SK-3280PF
Input Voltage		AC110~120V 50/60Hz			AC220~240V 50/60Hz		
Torque	(kgf.cm)	L 1.5~12 P 2.0~12	3~19	LF 1.5~12 PF 2.0~12	L 1.5~12 P 2.0~12	3~19	LF 1.5~12 PF 2.0~12
	(Lbf.in)	L 1.30~10.56 P 1.76~10.56	2.64~16.72	LF 1.30~10.56 PF 1.76~10.56	L 1.30~10.56 P 1.76~10.56	2.64~16.72	LF 1.30~10.56 PF 1.76~10.56
	(N.m)	L 0.15~1.18 P 0.19~1.18	0.29~1.86	LF 0.15~1.18 PF 0.19~1.18	L 0.15~1.18 P 0.19~1.18	0.29~1.86	LF 0.15~1.18 PF 0.19~1.18
Repeatable Torque Accuracy(%)		±3%					
Torque Adjustment		Stepless					
Free Speed(r.p.m)		1000	1000	2000	1000	1000	2000
Power Consumption		0.3A	0.3A	0.3A	0.2A	0.2A	0.2A
Screw Size Dia (mm)	Machine Screw	1.6~3.0	2.6~3.5	1.6~3.0	1.6~3.0	2.6~3.5	1.6~3.0
	Tapping Screw	1.6~2.6	2.6~3.0	1.6~2.6	1.6~2.6	2.6~3.0	1.6~2.6
Weight(g)		550					
Length(mm)		242					
ESD(Anti-Static)		-					
UL(Anyi-Static)		-					
CE		-					
RoHS		✓					
Bit Type							

Accessories



HIGH TORQUE AC-TYPE AUTOMATIC TRIGGER AND PUSH START CLUTCH TYPE SERIES



SK-8 Series 【SK-8130L, SK-8230L, SK-8130P, SK-8230P】



External Dimension

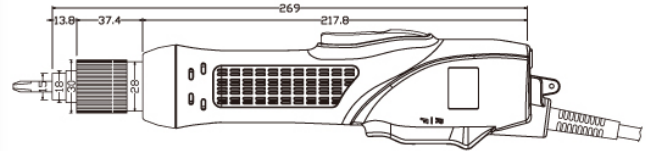

SK-8130L

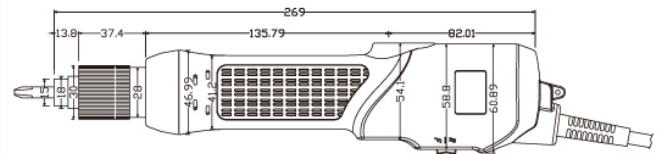

SK-8130P

Torque Range Chart

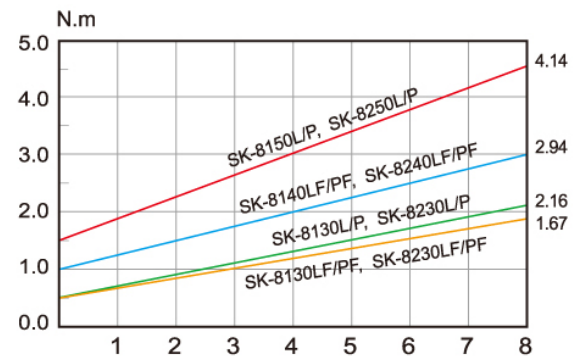

SK-8130L, SK-8230L
SK-8130P, SK-8230P

- Torque range 5-45kgf.cm (High torsion).
 - Stable torque precision $\pm 3\%$.
 - Best fit for assembling. Computer case and Tapping screw operation.
 - SK-8140LF/PF and SK-8240LF/PF models with exceeding 30kgf.cm Torque and 1,000 r.p.m Speed Output are special design of the tapping screw to joint Monitor Exterior Assemblies.
- ※ Conform to EMI, EMC International Safety Standards.

Specifications

Model		SK-8130L SK-8130P	SK-8140L SK-8140P	SK-8150L SK-8150P	SK-8130LF SK-8130PF	SK-8140LF SK-8140PF	SK-8230L SK-8230P	SK-8240L SK-8240P	SK-8250L SK-8250P	SK-8230LF SK-8230PF	SK-8240LF SK-8240PF
Input Voltage		AC110V~120V 50/60Hz					AC220V~240V 50/60Hz				
Torque	(kgf.cm)	5~22	10~30	15~45	5~17	10~30	5~22	10~30	15~45	5~17	10~30
	(Lbf.in)	4.4~19.36	8.8~26.4	13.2~39.6	4.4~14.75	8.8~26.4	4.4~19.36	8.8~26.4	13.2~39.6	4.4~14.75	8.8~26.4
	(N.m)	0.49~2.16	0.98~2.94	1.47~4.41	0.5~1.67	0.98~2.94	0.49~2.16	0.98~2.94	1.47~4.41	0.5~1.67	0.98~2.94
Repeatable Torque Accuracy(%)		±3%									
Torque Adjustment		Stepless									
Free Speed(r.p.m)		1000	700	500	1900	1000	1000	700	500	1900	1000
Power Consumption		0.4A	0.4A	0.4A	0.4A	0.4A	0.4A	0.4A	0.4A	0.4A	0.4A
Screw Size Dia (mm)	Machine Screw	2.6~4.0	3.0~5.0	4.0~6.0	2.3~4.0	3.0~5.0	2.6~4.0	3.0~5.0	4.0~6.0	2.3~4.0	3.0~5.0
	Tapping Screw	2.6~3.5	3.0~4.0	4.0~5.0	2.3~3.5	3.0~4.0	2.6~3.5	3.0~4.0	4.0~5.0	2.3~3.5	3.0~4.0
Weight(g)		700									
Length(mm)		269									
ESD(Anti-Static)		-									
UL(CUL)		-									
CE		-									
RoHS		✓									
Bit Type											

Accessories

Torque Fixing Ring
KC-1



Torque Adjuster
KW-1



Suspension Rack
KH-3



Spring Balancer
KL-1200



90° Degree
Attachment
KL-1



(only "L" type)



MEDIUM TORQUE AC-TYPE AUTOMATIC TRIGGER AND PUSH START CLUTCH TYPE SERIES

SK-9 Series 【SK-9131L, SK-9231L, SK-9131P, SK-9231P】

【SK-9131LF, SK-9231LF, SK-9131PF, SK-9231PF】



External Dimension

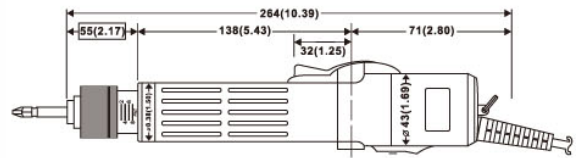

SK-9131L

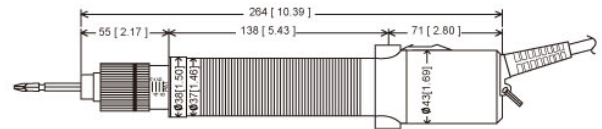

SK-9131P

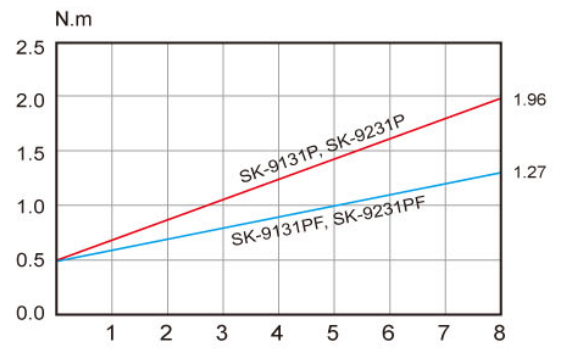

Torque Range Chart



SK-9131L, SK-9231L, SK-9131LF, SK-9231LF
SK-9131P, SK-9231P, SK-9131PF, SK-9231PF

- Small outer dimension, light-weight.
 - Mid-range torque 5-20 kgf.cm.
 - High rotation speed, torque accuracy $\pm 3\%$.
 - Best fit for general machine screws operation.
 - Torque adjustable and fixable with a fixing ring (KC-2).
- ※ Conform to EMI, EMC International Safety Standards.

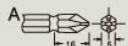
Specifications

Model		SK-9131L	SK-9131P	SK-9131LF	SK-9131PF	SK-9231L	SK-9231P	SK-9231LF	SK-9231PF
Input Voltage		AC110~120V 50/60Hz				AC220~240V 50/60Hz			
Torque	(kgf.cm)	5~20		5~13		5~20		5~13	
	(Lbf.in)	4.4~17.6		4.4~11.44		4.4~17.6		4.4~11.44	
	(N.m)	0.5~1.96		0.5~1.27		0.5~1.96		0.5~1.27	
Repeatable Torque Accuracy(%)		$\pm 3\%$							
Torque Adjustment		Stepless							
Free Speed(r.p.m)		1000		2000		1000		2000	
Power Consumption		0.3A		0.3A		0.2A		0.2A	
Screw Size Dia	Machine Screw	2.6~4.0		2.0~3.5		2.6~4.0		2.0~3.5	
	Tapping Screw	2.6~3.5		2.0~3.0		2.6~3.5		2.0~3.0	
Weight(g)		620							
Length(mm)		264							
ESD(Anti-Static)		-							
UL(CUL)		-							
CE		-							
RoHS		✓							
Bit Type									

Accessories

Torque Fixing Ring KC-2



Torque Adjuster KW-1



Suspension Rack KH-3



Spring Balancer KL-1200



90° Degree Attachment KL-1 (only "L" type)



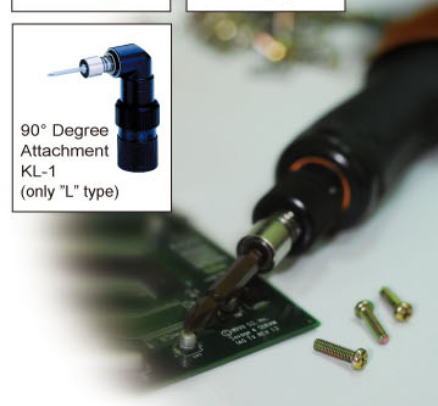

HIGH TORQUE AC-TYPE AUTOMATIC TRIGGER AND PUSH START CLUTCH TYPE SERIES



SK-9 Series 【SK-9130L, SK-9230L, SK-9130P, SK-9230P】



External Dimension

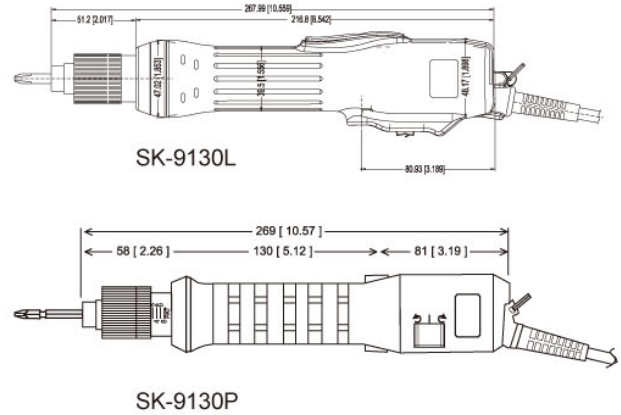

Torque Range Chart

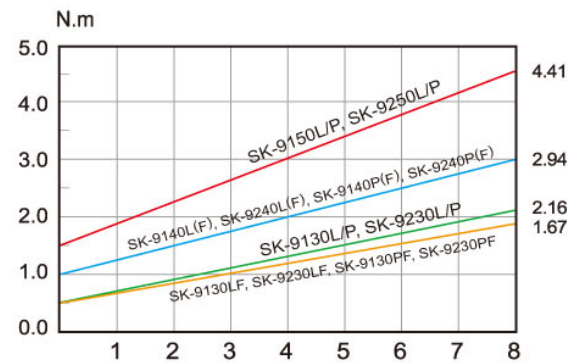

SK-9130L, SK-9230L
SK-9130P, SK-9230P

- Torque range 5-45 kgf.cm(High torsion), Stable torque precision $\pm 3\%$.
- Adjustable torsion and fixable with a torque fixing ring(KC-1).
- Grand torsion is applicable to install with pistol grip.
- Best fit for Computer case and Tapping screw operation.
- SK-9LF series approved by CE Standards.
- SK-9140LF/PF, SK-9240LF/PF, models with exceeding 30kgf.cm Torque and 1,000 r.p.m Speed Output are special design for the tapping screw to joint Monitor Exterior Assemblies.
- ※ Conform to EMI, EMC International Safety Standards.

Accessories

Specifications

Model		SK-9130L SK-9130P	SK-9140L SK-9140P	SK-9150L SK-9150P	SK-9130LF SK-9130PF	SK-9140LF SK-9140PF	SK-9230L SK-9230P	SK-9240L SK-9240P	SK-9250L SK-9250P	SK-9230LF SK-9230PF	SK-9240LF SK-9240PF
Input Voltage		AC110V~120V 50/60Hz					AC220V~240V 50/60Hz				
Torque	(kgf.cm)	5~22	10~30	15~45	5~17	10~30	5~22	10~30	15~45	5~17	10~30
	(Lbf.in)	4.4~19.36	8.8~26.4	13.2~39.6	4.4~14.75	8.8~26.4	4.4~19.36	8.8~26.4	13.2~39.6	4.4~14.75	8.8~26.4
	(N.m)	0.49~2.16	0.98~2.94	1.47~4.41	0.5~1.67	0.98~2.94	0.49~2.16	0.98~2.94	1.47~4.41	0.5~1.67	0.98~2.94
Repeatable Torque Accuracy(%)		±3%									
Torque Adjustment		Stepless									
Free Speed(r.p.m)		1000	700	500	1900	1000	1000	700	500	1900	1000
Power Consumption		0.4A	0.4A	0.4A	0.4A	0.4A	0.4A	0.4A	0.4A	0.4A	0.4A
Screw Size Dia (mm)	Machine Screw	2.6~4.0	3.0~5.0	4.0~6.0	2.3~4.0	3.0~5.0	2.6~4.0	3.0~5.0	4.0~6.0	2.3~4.0	3.0~5.0
	Tapping Screw	2.6~3.5	3.0~4.0	4.0~5.0	2.3~3.5	3.0~4.0	2.6~3.5	3.0~4.0	4.0~5.0	2.3~3.5	3.0~4.0
Weight(g)		700									
Length(mm)		269									
ESD(Anti-Static)											
UL(CUL)		✓									
CE							✓				
RoHS		✓									
Bit Type		A					B				

Torque Fixing Ring KC-1

Torque Adjuster KW-1

Suspension Rack KH-3

90° Degree Attachment KL-1 (only "L" type)

Spring Balancer KL-1200

Pistol Grip LG-2, PG-1



SKP-32HL-60W, SKP-32VR-60W, SKP-32HL-2H

- Output voltage : DC24V and DC32V two selections.
- Power switch : ON/OFF indicator. Two kinds of output voltage Hi & Lo.
- SKP-32HL/32VR-60W is a kind of intelligence power controller. Input 100V-240V by AC power source allows.
- SKP-32HL-60W has two output voltage levels, 32V and 24V, for user to choose.
SKP-32VR-60W can be freely adjusted, from output 32V to 24V, to meet the needs of certain work by users.
- Please set the torque scale below 4 for operation when the voltage of SKP series is set as Lo or blow 32V.
- Equipped with grounding device for eliminating static shock and anti-EMC.
- SKP-32HL-2H can provide power for 2 electric screwdrivers simultaneously.
- Please indicate the plug type.

Plug Feature

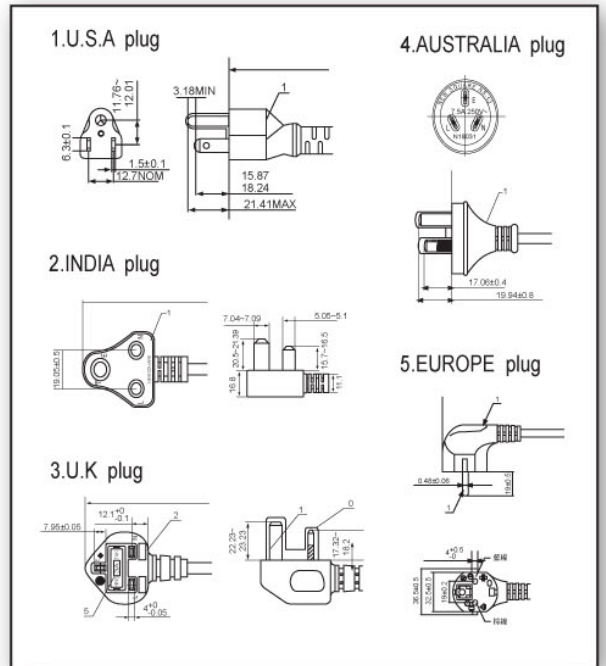

External Dimension

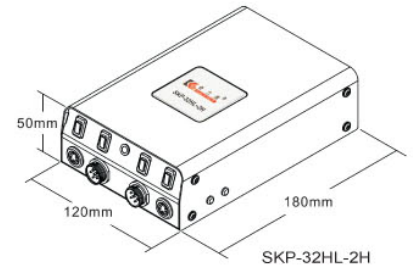
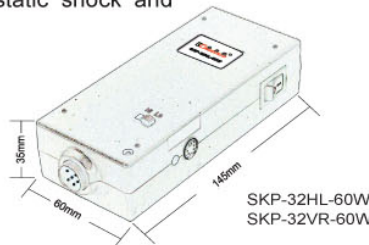

Specifications

Model	SKP-32HL-60W	SKP-32VR-60W	SKP-32HL-2H
Input Voltage	AC100~240V 50/60Hz		AC100~240V 50/60Hz
Output Voltage	Low DC24V Hi 32V		Low DC24V Hi 32V
Output Capacity	Low/Hi MAX2A		Low/Hi MAX5A
Outside Dimensions	145X60X35(mm)		120X180X50(mm)
Weight(g)	0.25kg(main body)		0.93kg(main body)
AC Cord Length	2M with ground		2M with ground
Suitable Model	One screwdriver SKD-2300L.SKD-2200L.SKD-2000L SKD-5200L. SKD-5200P SKD-5300L. SKD-5300P.SKD-5300LF.SKD-5300PF SKD-7000L. SKD-7000P.SKD-7200L. SKD-7200P SKD-7800L. SKD-7800P.SKD-7800LF. SKD-7800PF SKD-8300P.SKD-8400P.SKD-8500P.SKD-8300PF SKD-8300L.SKD-8400L.SKD-8500L.SKD-8300LF		Accept two screwdrivers SKD-2300L.SKD-2200L.SKD-2000L SKD-5200L. SKD-5200P SKD-5300L. SKD-5300P.SKD-5300LF.SKD-5300PF SKD-7000L. SKD-7000P.SKD-7200L. SKD-7200P SKD-7800L. SKD-7800P.SKD-7800LF. SKD-7800PF SKD-8300P.SKD-8400P.SKD-8500P.SKD-8300PF SKD-8300L.SKD-8400L.SKD-8500L.SKD-8300LF
ESD(Anti-Static)	-	-	-
UL(CUL)ETL	✓	✓	-
CE	✓	✓	-
RoHS	✓	✓	✓
Remark			

LOW TORQUE DC-TYPE AUTOMATIC TRIGGER START CLUTCH TYPE SERIES

SKD-2000 Series [SKD-2000L, SKD-2200L, SKD-2300L]



External Dimension

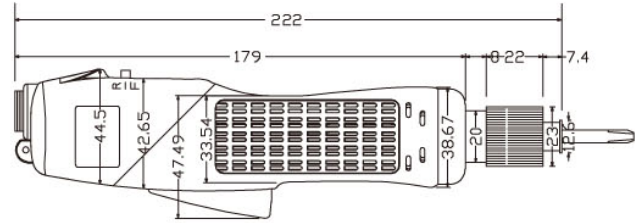

SKD-2000L, SKD-2200L, SKD-2300L

- New technology, ergonomic two-color housings, high temperature-resistant, vibration-resistant, friendly holder, fashionable appearance, light, good operation, free from fatigue under long-time using.
- Low stable torque 0.2kgf.cm and precision $\pm 3\%$.
- Small, light body 270g. specially design for the precise needing of tiny screws.
- High tech DC motor with parts made in JAPAN with high-quality extra strong magnet, low electric current, stable running, high stability and automatically stop as the screw fastened.
- 0-8 stepless torque adjustment, rotation speed selected by switches. Hi & Lo or VR (freely adjust).
- Best for industry of cell phones, digital cameras, notebook computers, PDA, DVD, MP3, CD-R, LCD and high-tech computer peripheral.
- Torque fixing ring (KC-4) can be set to fix torque. Slow start is optional for necessity.
- SKD-2000L Trigger series meet UL, CE approval and ESD is offered for the needs of customer.

Torque Range Chart

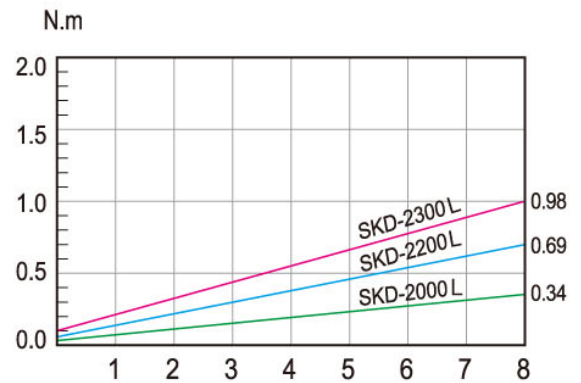

Specifications				
Model	SKD-2000L	SKD-2200L	SKD-2300L	
Input Voltage	DC24V or DC32V			
Power Consumption	25W			
Torque	(kgf.cm)	0.2~3.5	0.5~7	1~10
	(Lbf.in)	0.18~3.08	0.44~6.16	0.88~8.8
	(N.m)	0.02~0.34	0.05~0.69	0.1~0.98
Repeatable Torque Accuracy (%)	$\pm 3\%$			
Torque Adjustment	Stepless			
Free Speed (r.p.m)	HI	1000	1000	670
	LO	700	700	470
Screw Size Dia (mm)	Machine Screw	1.0~2.3	1.4~2.6	1.6~3.0
	Tapping Screw	1.0~2.0	1.4~2.3	1.6~2.6
Weight (g)	270			
Length (mm)	B=222		C=213	
ESD (Anti-Static)	✓	✓	✓	
CE	✓	✓	✓	
RoHS	✓	✓	✓	
Power Controller	SKP-32HL/32VR-60W			
Bit Type				

Accessories

<p>Torque Fixing Ring KC-4</p>	<p>Torque Adjuster KW-4</p>
<p>Suspension Rack KH-4</p>	<p>Slow Start Control Module KL-SS2</p>
<p>Spring Balancer KL-1200, KL-600</p>	<p>Power Controller SKP-32HL-60W, SKP-32VR-60W</p>



External Dimension

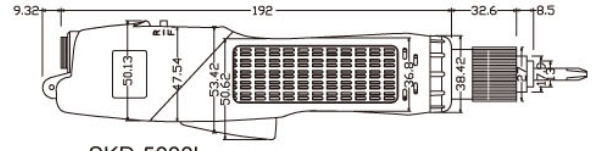

SKD-5000L

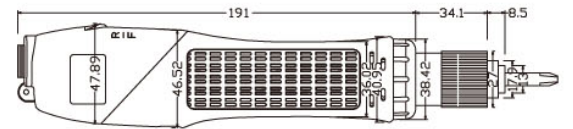

SKD-5000P

SKD-5200L, SKD-5300L, SKD-5300LF SKD-5200P, SKD-5300P, SKD-5300PF

- New technology, ergonomic two-color housing, high temperature-resistant, vibration-resistant, slip-resistant, friendly holder, free form fatigue under long-time using and high working efficiency.
- Low-voltage automatic clutch electric screwdrivers with power controllers, can keep long-time operation, high stability, no influence by fluctuated voltage and high efficiency.
- High tech DC motor with parts made in JAPAN. Fast start with low electric current. Stable rotation and precision ±3%.
- 0-8 stepless torque adjustment, rotation speed selected by switches Hi & Lo or VR(freely adjust).
- Suitable for high-tech PC, laptop, game cube, etc. Torque fixing ring(KC-6) can be set to fix torque.
- There are four kinds of bit holder-A,B,C,D. Any screw, socket and nut can be used.
- SKD-5200L Trigger series meet UL, CE approval and ESD is offered for the needs of customer.

Torque Range Chart

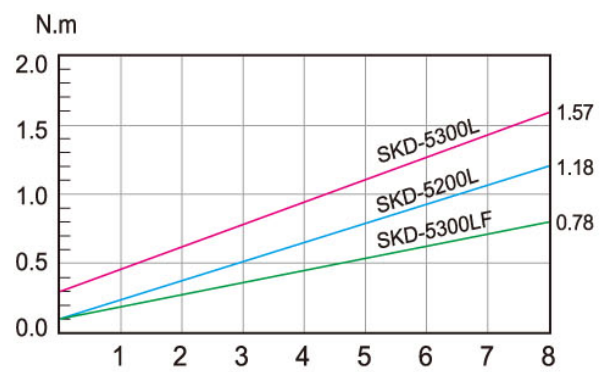

Specifications

Model		SKD-5200L	SKD-5200P	SKD-5300L	SKD-5300P	SKD-5300LF	SKD-5300PF
Input Voltage		DC24V or DC32V				DC32V	
Power Consumption		48W					
Torque	(kgf.cm)	1~12	2~12	3~16		1~8	2~8
	(Lbf.in)	0.88~10.56	1.76~10.56	2.64~14.08		0.88~7.04	1.76~7.04
	(N.m)	0.098~1.18	0.19~1.18	0.3~1.57		0.1~0.78	0.19~0.78
Repeatable Torque Accuracy(%)		±3%					
Torque Adjustment		Stepless					
Free Speed (r.p.m)	HI	1000		1000		2000	
	LO	700		700		-	
Screw Size Dia (mm)	Machine Screw	1.6~3.0		2.3~3.5		1.6~3.0	
	Tapping Screw	1.6~2.6		2.3~3.0		1.6~2.6	
Weight(g)		480					
Length(mm)		234					
ESD(Anti-Static)		✓		✓		✓	
CE		✓		✓		✓	
RoHS		✓		✓		✓	
Power Controller		SKP-32HL/32VR-60W				SKP-32HL/32VR-60W	
Bit Type							

Accessories

Torque Fixing Ring KC-6C

Torque Adjuster KW-3

Suspension Rack KH-4

Spring Balancer KL-1200

90° Degree Attachment KL-2 (only "L" type)

Slow Start Control Module KL-SS2

Power Controller

MEDIUM TORQUE DC-TYPE AUTOMATIC TRIGGER AND PUSH START CLUTCH TYPE SERIES



SKD-7000 Series [SKD-7000L, SKD-7200L, SKD-7800L, SKD-7800LF]
[SKD-7000P, SKD-7200P, SKD-7800P, SKD-7800PF]



External Dimension

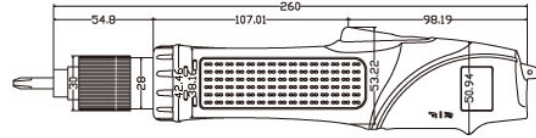

SKD-7000L

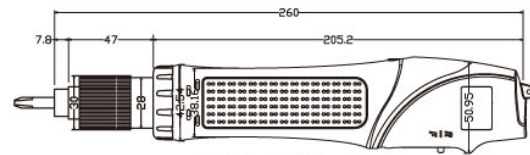

SKD-7000P

SKD-7000L, SKD-7200L, SKD-7800L, SKD-7800LF
SKD-7000P, SKD-7200P, SKD-7800P, SKD-7800PF

- Low-voltage automatic clutch electric screwdrivers with power controllers, can keep long-time operation, high stability, no influence by fluctuated voltage.
- Be operate with torque fixing ring (KC-2) most applied to office machines, PC peripherals.
- High technology motor, made by extra strong magnet, fast start and low electric current. Fan and vent let motors fast heat emission, low temperature for successive using.
- Clutch is made by alloy steel materials made in JAPAN, solid and endurance, fatigue-resistant, high stability and long lifespan.
- Precise torque is able to set from small to large, range stepless, stable, fast speed, easy operation and high working efficiency.
- Any screw and socket can be used. As fastening process reach pre-set torque, clutch will be automatically stopped as well.

Torque Range Chart

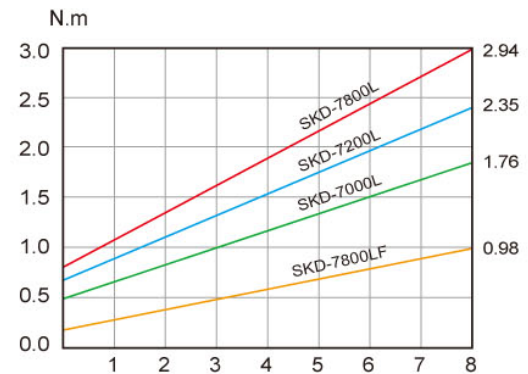

Specifications

Model		SKD-7000L	SKD-7000P	SKD-7200L	SKD-7200P	SKD-7800L	SKD-7800P	SKD-7800LF	SKD-7800PF
Input Voltage		DC24V or DC32V						DC32V	
Power Consumption		50W							
Torque	(kgf.cm)	5~18		7~24		8~30		2~10	
	(Lbf.in)	4.4~15.84		6.16~21.12		7.04~26.4		1.76~8.8	
	(N.m)	0.5~1.76		0.69~2.35		0.78~2.94		0.2~0.98	
Repeatable Torque Accuracy(%)		±3%							
Torque Adjustment		Stepless							
Free Speed (r.p.m)	HI	1000		750		530		2000	
	LO	700		520		350		-	
Screw Size Dia (mm)	Machine Screw	2.0~3.5		2.6~4.0		3.0~5.0		2.0~3.0	
	Tapping Screw	2.0~3.0		2.6~3.5		3.0~4.0		2.0~2.6	
Weight(g)		600							
Length(mm)		260							
ESD(Anti-Static)		✓		✓		✓		✓	
CE		✓		✓		✓		✓	
RoHS		✓		✓		✓		✓	
Power Controller		SKP-32HL/32VR-60W							
Bit Type									

Accessories

Torque Fixing Ring KC-2 	Torque Adjuster KW-1
Suspension Rack KH-2 	Spring Balancer KL-1200
90° Degree Attachment KL-1 (only "L" type) 	Slow Start Control Module KL-SS2
Power Controller 	

VACUUM TYPE SCREWDRIVERS

SKD-V2000 Series [SKD-V2000LC, SKD-V2200LC, SKD-V2300LC]



External Dimension

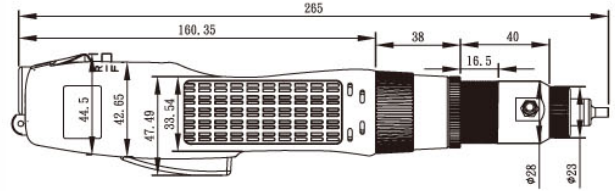

- Vacuum screwdriver was taking the series of SKD-V2000LC as reference and being created by adding the vacuum head. The main purpose is sucking the non-magnetic screws, such as plastic screws / aluminum-made screws / stainless steel screws and any other screws that does not contain magnetic screw.
- Any type and specification of screws can be sucked which only need to replace the head to KS-2.
- The volume of vacuum screwdriver pump is small; it is suitable to all kinds of vacuum screwdrivers.
- The suction of vacuum pump is powerful; if the screws tray is using together, it will be more convenient and easy. The screws can be placed at the tray first and then sucked by the vacuum screwdriver.



Specifications

Model		SKD-V2000LC	SKD-V2200LC	SKD-V2300LC
Input Voltage		DC24V or DC32V		
Torque	(kgf.cm)	0.3~3.5	0.5~7	1~10
	(Lbf.in)	0.26~3.08	0.44~6.16	0.88~8.8
	(N.m)	0.03~0.34	0.05~0.69	0.1~0.98
Repeatable Torque Accuracy(%)		±3%		
Torque Adjustment		Stepless		
Free Speed (r.p.m)	HI	1000	1000	670
	LO	700	700	470
Screw Size Dia (mm)	Machine Screw	1.0~2.3	1.4~2.6	1.6~3.0
	Tapping Screw	1.0~2.0	1.4~2.3	1.6~2.6
Power Consumption		25W		
Weight(g)		419		
Length(mm)		265		
ESD(Anti-Static)		✓		
CE		✓		
RoHS		✓		
Power Controller		SKP-32HL/32VR-60W		
Bit Type				



Bit nozzle specification

PART NO	d1	d2	D	H	Bit Dim (mm) T x D x L	
P11032	2.2	3	4	1.3	00X1.5X60	
P11032-1	2.7	4	5	1.5	0X2.0X60	
P11032-2	3.2	4.5	5.5	2	1X2.5X60	



KILEWS® SCREW COUNTER (FOR CARBON BRUSH) SKP-C32HL



External Dimension

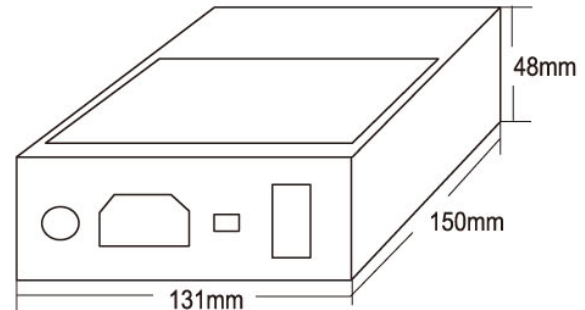

In order to resolve accurate counting on screw fastening and work together with PLC based process control system for electric screwdrivers, we integrate screw counter and power supply function into one unique device which is a power supply itself and a screw counter as well. The model number SKP-C32HL Screw Counter has taken into consideration of practicability and availability for user to operate it more convenient.

SKP-C32HL adds an Auto-Learning Function which allows user to operate it under the circumstance of unknown screw length and electric screwdrivers rotation speed, or user needs to fasten screws with slow- start function at the same time, SKP-C32HL can perform built-in learning function which makes Screw Counter to identify the best setting value for your screw fastening job.

Features

- It has the most complete function system such as able to SL, SC, RC, AT, LT, HT, LL, This is the most professional design and choice.
- Slow-Start function is able to set rotation speed and timing, it allows electric screwdriver to start under very low speed and stop at a normal speed.
- Selectable auto-reset retrieval or manual reset retrieval for setting up screw count.
- SKP-C32HL enhances the auto-identified screw fastening time mode, allow user to aim at simulating the duration of specific screw fastening.
- 5 sets of data can be stored. All 5 sets of data are able to used interchangeability at the same time. It's the best choice of screws counter due to one screwdriver can be used as 5 ones.
- Displaying the number of unfinished screw counts, user can add external sensor switch to prevent any operation error from neglect of fastening screws. Buzzer sounds on automatically to notify user while fastening job is done as screw setting number. Internal signal for detecting screw count is also able to connect external devices.
- SKP-C32HL is capable of equipping with output and input signal, such function is suitable for semi or full automatic production line to keep operator from improper operation and make an accurate calculation through the signal of sensor.
- Enable to connect with external PLC system to streamline production line. Calculate the screws numbers to be fastened by computer to avoid any unnecessary neglect of screw fastening.
- SKP-C32HL provides with +32V/+20V of DC voltage, if user requires such power source, it can be connected to V+(+) and COM(-), and then connect to controlling PLC. Input Voltage range from AC100V to 240V.

Specifications

Model	SKP-C32HL
Input Voltage	AC100V~240V 50/60Hz
Output Voltage	DC 32V/20V 15A
Count	1~99
Count method	Count-up/Count-down
Work with Sensor	ON/OFF
GATE Sensor	ON(2Sensor)/OFF(1Sensor)
Slow-start time adjustable	0~9.9 seconds
Slow-start speed adjustable	60%~100% Rated Speed
Running Time limit-LO	0~9.9 seconds
Running Time limit-HI	0~9.9 seconds
NG alarm	On/Off/FF/EF with LED and buzzer
OK alarm	On/Off/FF/EF with LED and buzzer
Auto ZERO	ON/OFF
External inputs	Sensor/Reset
External outputs	OK/NG/OK all
Screwdriver Control	Speed : HI/LO (SLOW START)
Outside Dimensions	150X48X130(mm)
Accessories	Power cordX1 Suspension bailX2 Terminal BlockX1
Remark	

DC-TYPE SCREWDRIVERS (FOR SKP-C32HL ONLY)

SKD-C2000/5000/7000/8000 Series

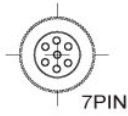

SKD-C2000L
SKD-C2200L
SKD-C2300L



SKD-C5200L
SKD-C5300L
SKD-C5300LF



SKD-C5200P
SKD-C5300P
SKD-C5300PF

Specifications

Model		SKD-C2000L	SKD-C2200L	SKD-C2300L	SKD-C5200L/P	SKD-C5300L/P	SKD-C5300LF/PF
Torque	(kgf.cm)	0.2~3.5	0.5~7	1~10	L 1~12 P 2~12	3~16	LF 1~8 PF 2~8
	(Lbf.in)	0.18~3.08	0.44~6.16	0.88~8.8	L 0.88~10.56 P 1.76~10.56	2.64~14.08	LF 0.88~7.04 PF 1.76~7.04
	(N.m)	0.02~0.34	0.05~0.69	0.1~0.98	L 0.1~1.18 P 0.19~1.18	0.29~1.57	LF 0.1~0.78 PF 0.19~0.78
Specifications Speed (r.p.m)±10%	HI	1000	1000	670	1000	1000	2000
	LO	700	700	470	700	700	--
Screw Size Dia (mm)	Machine Screw	1.0~2.3	1.4~2.6	1.6~3.0	1.6~3.0	2.3~3.5	1.6~3.0
	Tapping Screw	1.0~2.0	1.4~2.3	1.6~2.6	1.6~2.6	2.3~3.5	1.6~2.6
Weight(g)		270	270	270	480	480	480
Length(mm)		205	205	205	230	230	230

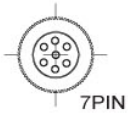

SKD-C7000L
SKD-C7200L
SKD-C7800L
SKD-C7800LF



SKD-C7000P
SKD-C7200P
SKD-C7800P
SKD-C7800PF



SKD-C8300L
SKD-C8400L
SKD-C8500L
SKD-C8300LF



SKD-C8300P
SKD-C8400P
SKD-C8500P
SKD-C8300PF

Specifications

Model		SKD-C7000L/P	SKD-C7200L/P	SKD-C7800L/P	SKD-C7800LF/PF	SKD-C8300L/P	SKD-C8300LF/PF	SKD-C8400L/P	SKD-C8500L/P
Torque	(kgf.cm)	5~18	7~24	8~30	2~10	6~22	5~12	10~30	15~45
	(Lbf.in)	4.4~15.84	6.16~21.12	7.04~26.4	1.76~8.8	5.28~19.36	4.4~10.56	8.8~26.4	13.2~39.6
	(N.m)	0.5~1.76	0.69~2.35	0.78~2.94	0.2~0.98	0.59~2.16	0.5~1.18	0.98~2.94	1.47~4.41
Specifications Speed (r.p.m)±10%	HI	1000	750	530	2000	1000	2000	750	530
	LO	700	520	350	--	700	--	450	300
Screw Size Dia (mm)	Machine Screw	2.0~3.5	2.6~4.0	3.0~5.0	2.0~3.0	2.6~4.0	2.3~3.5	3.0~5.0	4.0~6.0
	Tapping Screw	2.0~3.0	2.6~3.5	3.0~4.0	2.0~2.6	2.6~3.5	2.0~3.0	3.0~4.5	3.0~5.0
Weight(g)		600	600	600	600	700	700	700	700
Length(mm)		260	260	260	260	269	270	270	270



SCREW COUNTER(KCT-01)

The number of those screws, which are not tightened yet, can be counted and displayed on the screw counter. If the screw tightening process stopped during working, the buzzer will sound automatically to warn the users. This is applied to AC Type Full-Auto Electric Screwdrivers.

Specifications

Model	KCT-01
Screwdrivers	1
The number of	1~99
setting counts Time setup	LO TIME 0.0~2.0 sec.
	HI TIME 0.0~9.0 sec.
Function	LCBA
Size	80(H)X75(W) X13(D)/94g

KILEWS® LOW TORQUE AC-TYPE SEMI-AUTOMATIC TRIGGER START CLUTCH TYPE SERIES

SK-2 Series 【SK-205LS, SK-215LS, SK-2205LS, SK-2215LS】



External Dimension

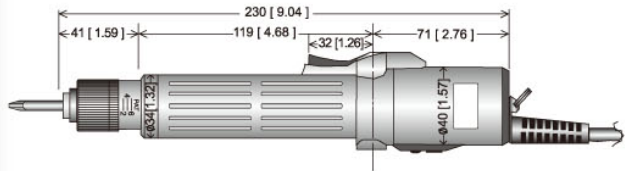

Torque Range Chart

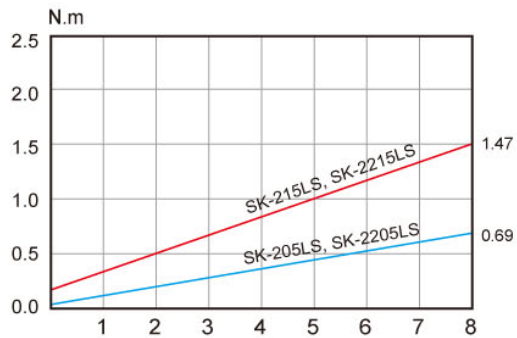

SK-205LS, SK-215LS, SK-2205LS, SK-2215LS

- AC plug; no adaptor needed.
- Inner dual insulator which is conforming to the international safety standard. 100% safe, small volume, light and handy, easy to use and appearance fits in with ergonomics logic
- Highly precise of torque. It is adjustable from small to large but speed stays constant. The rotation speed is fast and also light and handy. Working utility can increase.
- Best choice for general electronic appliances, such as lamps, small home appliances, toys and etc.

Specifications					
Model		SK-205LS	SK-215LS	SK-2205LS	SK-2215LS
Input Voltage		AC110~120V 50/60Hz		AC220~240V 50/60Hz	
Torque	(kgf.cm)	0.5~7	2~15	0.5~7	2~15
	(Lbf.in)	0.44~6.16	1.76~13.2	0.44~6.16	1.76~13.2
	(N.m)	0.05~0.69	0.19~1.47	0.05~0.69	0.19~1.47
Repeatable Torque Accuracy(%)		±5%			
Torque Adjustment		Stepless			
Free Speed(r.p.m)		1000	1000	1000	1000
Power Consumption		0.3A	0.3A	0.2A	0.2A
Screw Size Dia (mm)	Machine Screw	1.4~2.6	2.0~4.0	1.4~2.6	2.0~4.0
	Tapping Screw	1.4~2.0	2.0~3.0	1.4~2.0	2.0~3.0
Weight(g)		480			
Length(mm)		230			
ESD(Anti-Static)		-			
UL(CUL)		-			
CE		-			
RoHS		✓			
Bit Type					

Accessories

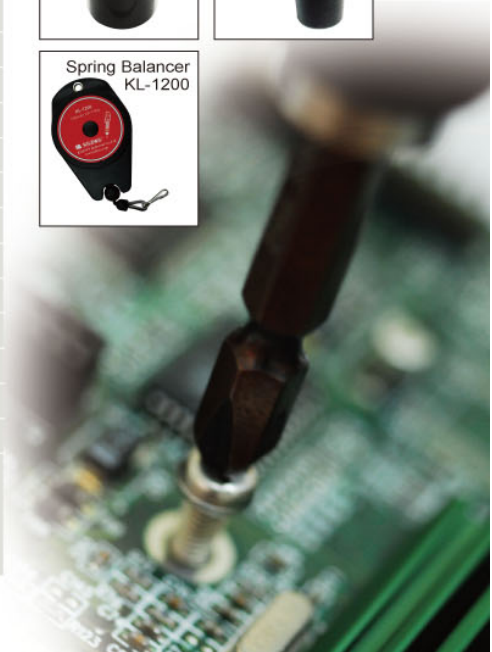

MEDIUM & HIGH TORQUE AC-TYPE SEMI-AUTOMATIC TRIGGER START CLUTCH TYPE SERIES



SK-2 Series 【SK-2125LS/LSF, SK-2135LS, SK-2145LS】
 【SK-2225LS/LSF, SK-2235LS, SK-2245LS】



External Dimension

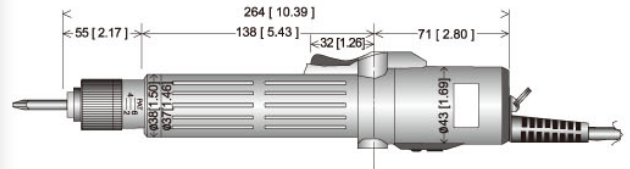

Torque Range Chart

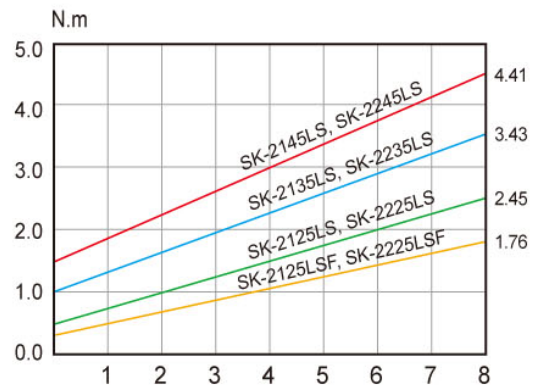

SK-2125LS, SK-2135LS, SK-2145LS, SK-2125LSF, SK-2225LS, SK-2235LS, SK-2245LS, SK-2225LSF,

- Torque range is from 5-45kgf.cm., Torque accuracy $\pm 5\%$
- Easy to operate and able to improve production efficiency
- Suitable when assembling for the out shell screws of general home electric appliances.
- The best choice when composing the tapping screws under 5mm diameter.

Specifications

Model	SK-2125LS	SK-2135LS	SK-2145LS	SK-2125LSF	SK-2225LS	SK-2235LS	SK-2245LS	SK-2225LSF	
Input Voltage	AC110~120V 50/60Hz				AC220~240V 50/60Hz				
Torque	(kgf.cm)	5~25	10~35	15~45	5~18	5~25	10~35	15~45	5~18
	(Lbf.in)	4.4~2.2	8.8~30.8	13.2~39.6	4.4~15.84	4.4~2.2	8.8~30.8	13.2~39.6	4.4~15.84
	(N.m)	0.49~2.46	0.95~3.43	1.47~4.41	0.5~1.76	0.49~2.46	0.95~3.43	1.47~4.41	0.5~1.76
Repeatable Torque Accuracy(%)	$\pm 5\%$								
Torque Adjustment	Stepless								
Free Speed(r.p.m)	1000	700	500	2000	1000	700	500	2000	
Power Consumption	0.3A	0.3A	0.3A	0.3A	0.3A	0.3A	0.3A	0.3A	
Screw Size Dia (mm)	Machine Screw	2.6~4.0	3.0~5.0	4.0~6.0	2.6~4.0	2.6~4.0	3.0~5.0	4.0~6.0	2.6~4.0
	Tapping Screw	2.6~3.5	3.0~4.0	4.0~5.0	2.6~3.5	2.6~3.5	3.0~4.0	4.0~5.0	2.6~3.5
Weight(g)	600								
Length(mm)	264								
ESD(Anti-Static)	-								
UL(CUL)	-								
CE	-								
RoHS	✓								
Bit Type									

Accessories





● The torque meters are directly produced by the manufacturer **KILEWS** in Japan, authorized by Kilews Industrial Co., Ltd. by ODM. Each product will be provided with an Adjustment Certificate and one year Warranty in normal using. Take Note! These measuring instruments could not be applied in testing the pneumatic screwdriver products and prohibited in measuring the torque exceeding maximum measuring range of torque meters.

KTM-10, KTM-100

- LED can identify the test range of torque setting by needed user. If the result is not complying to torque range setting, light will be warned.
- USB 1.0 connector is only used for data output : it is convenient for user to work with computer.
- Auto-zero can be selected and zero reset becomes unnecessary for user.
- Automatically test values about maximum, minimum and mean.

Specifications

Model		KTM-100	KTM-10	KTM-50S	KTM-CSH	KTM-6
Measuring Rangs	(kgf.cm)	1.5~100.0	0.15~10.0	0.5~50.0	30.0~200.0	0.020~6
	(Lbf.in)	1.5~90.0	0.15~9.0	0.434~43.40	30.0~180.0	0.020~5.22
	(N.m)	0.15~10.00	0.015~1.0	0.04~4.90	3.00~20.00	0.002~0.6
Accuracy				With in ±0.5%		
Power Supply				1.2V batteryX5		
Charging Time				With in 8 hours		
Continuous Operation At Full Charge				About 30 hours		
Battery				Rechargeable 300 times or more		
Dimension	mm	123X230X65(H)		180X130X34(H)		160X125X55(H)
Weight	kg	2.0				1.2
Special Charger		Input AC120V, 220~240V Output DC12V 500mA		Input AC120V, 220~240V Output DC7.5V 500mA		Input AC120V, 220~240V Output DC12V 500mA
Note		For Screwdrivers			For Hinge	
Accessory		Torque measuring adaptorX2 SJ-10K / SJ-50	Torque measuring adaptorX2 SJ-3 / SJ-10	Torque measuring adaptorX1 SJ-50	Torque measuring adaptorX1 SJ-100	Torque measuring adaptorX1 SJ-3

IDLY ROTATING TORQUE SCREWDRIVER



TD Series [TD-1.5K, TD-3K, TD-6K, TD-12K, TD-20K, TD-30K, TD-50K, TD-100K]

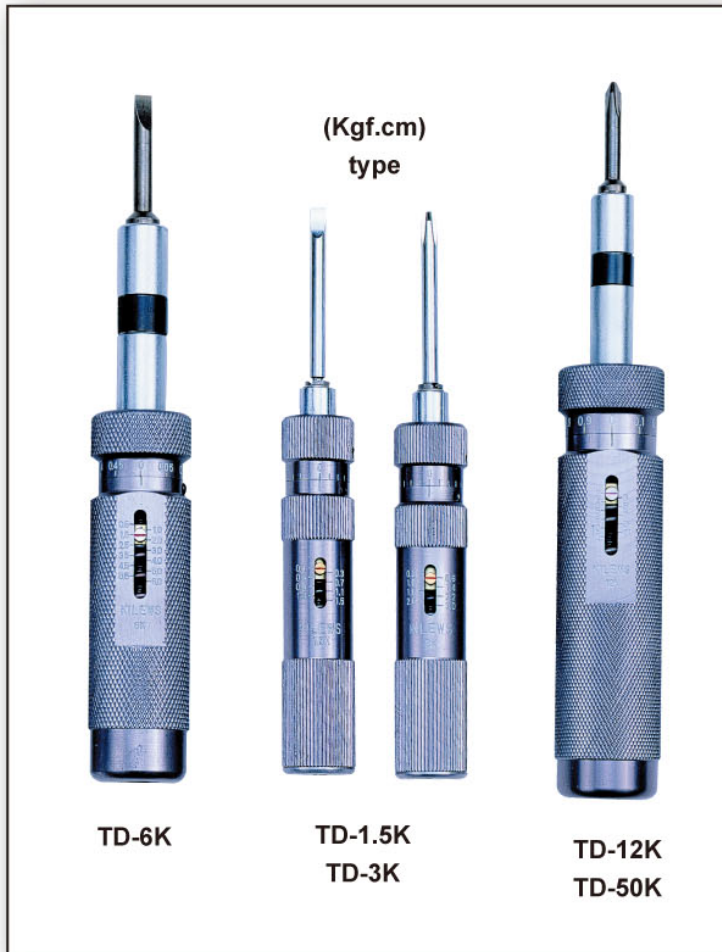

Screwdrivers Composition

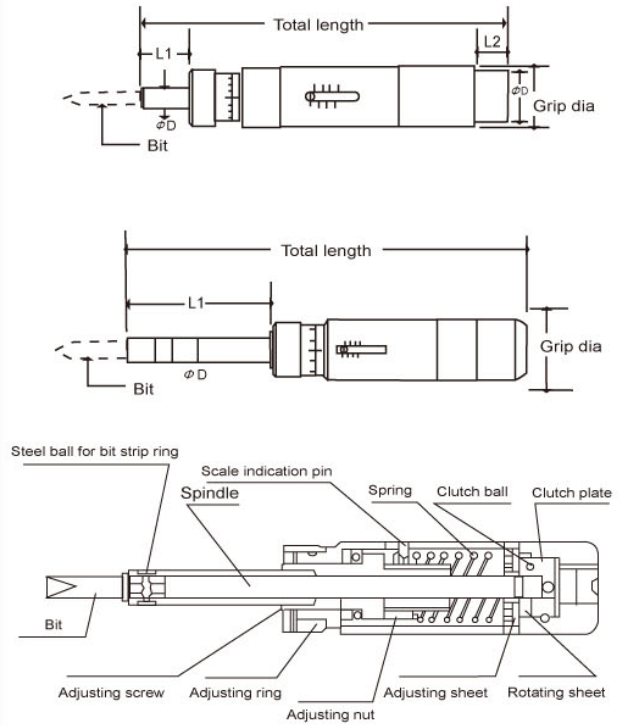

The above picture is kgf.cm type

Screwdrivers Assembling Line



- (1) Select a bit to match screw.
- (2) Rotate the adjusting ring and set a torque.
- (3) Tighten the screw until idly rotated. Available for both left and right

Idly rotation prevents excessively tightening at the torque setting. Not fatigued with a long time use.

- Light and short, easy to operate, and favorable sound touch sensibility at idly rotation.
- Set up required torque value and tightened, everyone can tighten in the same way.
- When reaching specified torque, the clutch will be released automatically, and idly rotated, therefore this action prevents excessively tightening.
- (+) and (-) bit 1pc, respectively are attached.
- Various bits are prepared.
- Used for both left and right turns.
- Max. accuracy $\pm 3\%$ and 1 scale assured.

Specification

Model LTDK	Torque	Grad.	Grip Dia.	Total Length (without bit)	Main Size(mm)				Weight	Attachment Bit	
	kgf.cm				Φmm	mm	L1	L2		ΦD1	ΦD2
TD-1.5K	0.1~1.5	0.01	18	86	8.5	8	8	45	No.1	0.4X3.5	Original
TD-3K	0.2~3	0.02									
TD-6K	0.5~6	0.05	25	106	36	10	19	90	No.1 (4Φ)	0.4X0.4	Common with marketed products
TD-12K	2~12	0.1	30	140	39.5	8.5	24	150			
TD-20K	4~20	0.1	34	150	60	10	10	210	No.2 (7Φ)	1.0X7.0	
TD-30K	4~30	0.1						215			
TD-50K	10~50	0.25	40	200	73	11	11	440			
TD-100K	20~100	0.6	45	235	100	11	11	790			



KILEWS® SCREW FEEDER KFR-1050



Automatic, quickness and accuracy are the essential performances required and improved by great ideas from the most users and dealers, in return KFR-1050 possess these talents and gives the most satisfactory status on operating and distributing. For the best efficiency of this unit please peruse the manual closely before operating the unit.

Specifications

Model Name & Number	KFR-1050 Automatic Screw Feeder
Size	182(W)X126(L)X147(H) mm
Weight	N.W. : Approx 2.17 Kgs (excluding switching adaptor)
Power Source	AC 100~240V
Switching Adaptor	DC 15V Switching Adaptor
Applicable Screw	From M1.0 to M5.0
Applicable Screw length	Up to 19mm(under head)
Scooping Chamber Capacity	200~220 cc
Accessories (in package & box)	Allen Wrench (L Shaped 2.0 x 107 mm) X1 pc. Switching Adaptor x 1 Set. Accessory(front) (0.8 , 1.0 , 1.2 , 1.5 , 2.0 x 70 mm)X1 pc. Accessory(behind) (0.2 x 10 x 20 mm)X2 pcs (0.5 x 10 x 20 mm)X10 pcs. Stopper 2.0~5.0mmX1 pc. Instruction Manual
Package Size	Each Set/Box : 282(L)X142(W)X201(H)mm Each Set/Box : 450(L)X310(W)X435(H)mm
Package Weight (Including Machine)	Each Set/Box G.W : Approx 2.63 Kgs Each Carton G.W : Approx 16.53 Kgs(One Box=6 Sets)

Features

- **WIDEST RANGE OF APPLICABLE SCREW SIZES :**
Between 1.0~5.0mm (Incl.: 1.0mm,1.2mm, 1.4mm, 1.7mm, 2.0mm, 2.3mm, 2.6mm, 3.0mm, 3.5mm, 4.0mm, & 5.0mm,)
11 sizes.
- **MAX OF SCREWS LENGTH & HOPPER CAPACITY :**
Screw Length : Up to 19mm (under screw head)
Capacity of hopper : 200~220 c.c
- **APPLICABILITY OF SPECIAL SCREW TYPES :**
Screw Length \geq Thread Diameter (1 \geq 1)
Thickness of screw head \geq 0.2mm
No jamming or failure occurred with these applicable types
And affect productivity.
- **SIZE OF FEEDING RAIL IS ADJUSTABLE :**
Feeding rail can be pulled out for width adjusts to the applied
Sizes easily. Measurements for width adjusting can be in
Metric or Imperial units.
- **SAVE PARTS COSTS & STOCK :**
KFR-1050 allows adjusting the width of feeding rail to serve 11
sizes screws, between 1.0mm to 5.0mm diameter. The
flexibility prevents dealers from stocking up on quantities for
different sizes, and reduces the cost on related accessories
for users.
- **ADJUSTABLE VIBRATION INTENSITY :**
With vibration in small amplitude at high strength, it moves
screws On rail to pick-up point in good order, no overlay or
jamming to Affect the speed of movement and productivity.
- **HUMANIZED MULTI PROGRAMMING CONTROL:**
*Individual drive system for feeding and vibrating operation.
*Setting for suitable stop time without interapt to operate.
*Equipped ground wire, socket & buzzer for operative safety
and alarm signal.
*PCB controls for efficiencies of desired speed & timing on
each operating step.
*Switching Adaptor allowed AC 100~240V power source for
stable DC 15V output No influences and problems due to the
different AC power source of factories locations.



ACCESSORIES



KP, KL, Series [KP-AUXA, KP-AUX1T, KP-VAR, KP-VA1, KP-AUX2, KP-AUX5]
[KL-SS2, KL-SSB, KL-1, KL-2]



KP-AUXA, KP-AUX1T



Auxiliary Arm

KP-AUXA, KP-AUX1T

- Provide with the rocker arm , enable to revolve on 360 degrees.
- Main shaft can be extended to maximum 830mm
- Power arm inside includes nitrogen gas stick , allow user to grab the arm easily, automatic lift up to position after finishing the work .
- Easy to assemble and Disassemble.
- Optional accessory KP-VA1, KP-VAR(90 degree adapter) is available for user to Adjust angle in accordance with the object to be fastened.

KP-AUX2, KP-AUX5

- Main shaft can be extended to maximum 340mm
- Steady Bearing in horizontal direction for screwdriver to act in vertical precisely.
- Utilize KL-1200 to suspend the spring hoist vertically and capable of making adjustment at screwdriver's weight.
- Steady screwdriver with 4 sides of plate , the screwdriver head of horizontal and vertical position becomes more accurate.
- Apply to low torque , high precision screwdriver, most suitable for small objects.



KP-VAR, KP-VA1

Specifications

Model	KP-AUXA	KP-AUX1T	KP-AUX2	KP-AUX5
Description	Suspension Arm	Suspension Arm	Suspension Rope	Suspension Rope
Reach	50mm~830mm	50mm~830mm	50mm~340mm	50mm~340mm
Applicable Models	SKD-RB75L/P SKD-RB100L/P SKD-RB120L/P SKD-RB180L/P	SK-8 Series SK-9 Series SKD-8000 Series	SKD-2000L SKD-2200L SKD-2300L SKD-B203L SKD-B207L SKD-B210L	SKD-5200L/P SKD-5300L/P SKD-5300LF SKD-5300PF
Remark	KP-VAR adaptable	KP-VA1 adaptable	Spring Balancer KL-1200 adaptable	Spring Balancer KL-1200 adaptable

※ The auxiliary arm can be used only with Kilews electric screwdrivers.



KL-SS2

KL-SSB

Slow Start Control Module

KL-SS2

- Be applied to Kilews DC Electric Screwdrivers series.
- Slow Start can be adjusted to 0~3 seconds.
- The speed of Slow Start can be adjusted to 30%~100% of normal one.
- Output signal for brake:24VDC,200mA.
- Bypass Switch can stop Slow Start and easy to reverse screws.
- Dimension 58X95X35mm(LXWXH)

KL-SSB

- The BYPASS system is able to cancel the slow motion operation when counter-clockwise rotation is detected.
- Easily losing the screws reversely.
- Rotation in the slow motion is 30%~100% comparing to regular rotation.
- Selection of adjusting stages: L1-L2-L3 ...L9-L0-L1.
- Supplying the output signals of start /break/rotation in clock or counter-clockwise.
- Applying to any non-carbon-brush series of Kilews
- the operation of slow motion time can be adjusted to 0.1~5.0secs.
- Dimension 58X95X35mm(LXWXH)

	90° Degree Attachment Applicable Model
KL-1	SKD-B830L, SKD-B850L, SKD-7000L, SKD-7200L, SKD-7800L, SKD-8300L, SKD-8400L, SKD-8500L, SK-8130L, SK-8230L, SK-8140L, SK-8240L, SK-8150L, SK-8250L, SK-9131L, SK-9231L, SK-9130L, SK-9230L, SK-9140L, SK-9240L, SK-9150L, SK-9250L,
KL-2	SKD-5200L, SK-3220L, SK-3180L, SKD-B512L, SKD-5300L, SK-3120L, SK-3280L, SKD-B519L,

※ Only "L" trigger start screwdrivers

90° Degree Attachment



90° Degree Attachment KL-1

KL-2



Suspension Rack

	Applicable Models			
KH-1	SK-2125LS(&KC), SK-2225LS(&KC), SK-9131L/P(&KC), SK-9130L/P(&KC), SK-9140L/P(&KC), SK-9140LF/PF(&KC), SK-9230LF/PF(&KC), SK-8150L/P(&KC), SK-8240L/P(&KC), SKD-7000L/P(&KC), SKD-8300L/P(&KC),	SK-2135LS(&KC), SK-2235LS(&KC), SK-9131LF/PF(&KC), SK-9140L/P(&KC), SK-9230L/P(&KC), SK-9240LF/PF(&KC), SK-8130L/PF(&KC), SK-8130LF/PF(&KC), SK-8250L/P(&KC), SKD-7200L/P(&KC), SKD-8400L/P(&KC),	SK-2145LS(&KC), SK-2245LS(&KC), SK-9231L/P(&KC), SK-9150L/P(&KC), SK-9240L/P(&KC), SK-8140LF/PF(&KC), SK-8230LF/PF(&KC), SKD-7800L/P(&KC), SKD-8500L/P(&KC),	SK-2125LSF(&KC), SK-2225LSF(&KC), SK-9231LF/PF(&KC), SK-9130LF/PF(&KC), SSK-9250L/P(&KC), SK-8140L/P(&KC), SK-8230L/P(&KC), SKD-7800LF/PF(&KC), SKD-8300LF/PF(&KC),
	SKD-7000L/P(two color), SKD-7800LF/PF(two color), SK-3180LF/PF(two color &KC), SK-3280LF/PF(two color &KC), SKD-5300L/P(two color &KC), SKD-B512L/P(&KC),	SKD-7200L/P(two color), SK-3120L/P(two color &KC), SK-3220L/P(two color &KC), SKD-5200L/P(two color &KC), SKD-B519L/P(&KC),	SKD-7800L/P, SK-3180L/P(two color &KC), SK-3280L/P(two color &KC), SKD-B830L/P, SKD-B850L/P, SKD-B830LF/PF, SKD-BE830L/P, SKD-BE850L/P, SKD-BE830LF/PF, SKD-B512LF/PF(&KC), SKD-BE512LF/PF(&KC),	
KH-2	SK-2125LS, SK-2135LS, SK-2145LS, SK-2125LSF, SK-2225LS, SK-2235LS, SK-2245LS, SK-2225LSF, SK-3120L(one color), SK-3180L(one color), SK-3180LF(one color), SK-9130L/P, SK-9140L/P, SK-9150L/P, SK-9140LF/PF, SK-9130LF/PF, SK-9230L/P, SK-9240L/P, SK-9250L/P, SK-9230LF/PF, SK-9240LF/PF, SK-8130L/P, SK-8140L/P, SK-8150L/P, SK-8130LF/PF, SK-8140LF/PF, SKD-8300L/P, SKD-8400L/P, SKD-8500L/P, SKD-8300LF/PF, SK-8230L/P, SK-8250L/P, SK-8230LF/PF, SK-8240LF/PF, SK-9131L/P, SK-9131LF/PF, SK-9231L/P, SK-9231LF/PF			
	SK-3120L(one color &KC), SK-3180L(one color &KC), SK-3180LF(one color &KC), SKD-2000L(two color &KC), SKD-2200L(two color &KC), SKD-2300L(two color &KC),			
KH-3	SK-205LS, SK-215LS, SK-2205LS, SK-2215LS, SK-3120P(one color), SK-3180P(one color), SK-3180PF(one color), SK-3120L/P(two color), SK-3180L/P(two color), SK-3180LF/PF(two color), SK-3220L/P(two color), SK-3280L/P(two color), SK-3280LF/PF(two color), SKD-5200L/P, SKD-5300L/P, SKD-5300LF/PF, SKD-B512L/P, SKD-BE512L/P, SKD-BE512LF/PF, SKD-BE519L/P, SKD-BE517LF/PF, SKD-B519L/P, SKD-B512LF/PF, SKD-2000L, SKD-2200L, SKD-2300L,			
	SKD-B203L(&KC), SKD-B207L(&KC), SKD-B210L(&KC), SKD-B203L, SKD-B207L, SKD-B210L,			
KH-4	SK-205LS, SK-215LS, SK-2205LS, SK-2215LS, SK-3120P(one color), SK-3180P(one color), SK-3180PF(one color), SK-3120L/P(two color), SK-3180L/P(two color), SK-3180LF/PF(two color), SK-3220L/P(two color), SK-3280L/P(two color), SK-3280LF/PF(two color), SKD-5200L/P, SKD-5300L/P, SKD-5300LF/PF, SKD-B512L/P, SKD-BE512L/P, SKD-BE512LF/PF, SKD-BE519L/P, SKD-BE517LF/PF, SKD-B519L/P, SKD-B512LF/PF, SKD-2000L, SKD-2200L, SKD-2300L,			
	SKD-B203L(&KC), SKD-B207L(&KC), SKD-B210L(&KC), SKD-B203L, SKD-B207L, SKD-B210L,			
KH-5	SK-205LS, SK-215LS, SK-2205LS, SK-2215LS, SK-3120P(one color), SK-3180P(one color), SK-3180PF(one color), SK-3120L/P(two color), SK-3180L/P(two color), SK-3180LF/PF(two color), SK-3220L/P(two color), SK-3280L/P(two color), SK-3280LF/PF(two color), SKD-5200L/P, SKD-5300L/P, SKD-5300LF/PF, SKD-B512L/P, SKD-BE512L/P, SKD-BE512LF/PF, SKD-BE519L/P, SKD-BE517LF/PF, SKD-B519L/P, SKD-B512LF/PF, SKD-2000L, SKD-2200L, SKD-2300L,			
	SKD-B203L(&KC), SKD-B207L(&KC), SKD-B210L(&KC), SKD-B203L, SKD-B207L, SKD-B210L,			

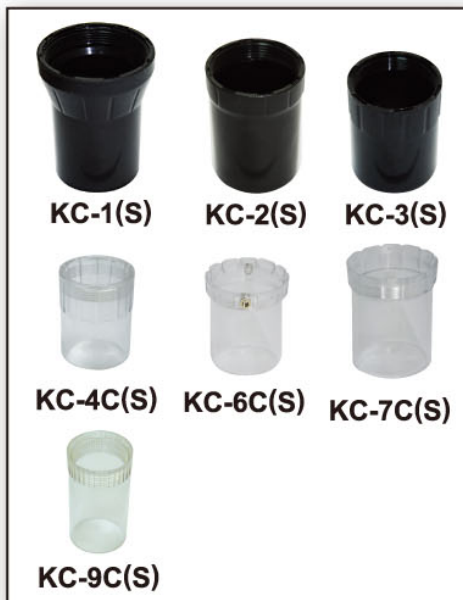

Torque Fixing Ring

	Applicable Models
KC-1(S)	SK-8230L/P(LF/PF), SK-8240L/P(LF/PF), SK-8250L/P, SK-9150L/P, SK-9130L/P(LF/PF), SK-9140L/P(LF/PF), SKD-8300L/P(LF/PF), SKD-8400L/P, SKD-8500L/P,
KC-2(S)	SKD-7000P/L, SKD-7200P/L, SKD-7800P/L, SKD-7800PF/LF, SK-9131L/P, SK-9231L/P, SK-2125LS, SK-2135LS, SK-2145LS, SK-2125LSF, SK-2225LS, SK-2235LS, SK-2245LS, SK-2225LSF,
KC-3(S)	SK-3120L/P(one color), SK-3180L/P(LF/PF)(one color), SK-215L, SK-205L, SK-2215L, SK-2205L, SK-205LS, SK-2205LS,
KC-4C(S)	SKD-2000L, SKD-2200L, SKD-2300L, SKD-B203L, SKD-B207L, SKD-B210L,
KC-6C(S)	SK-3220L/P, SK-3280L/P(LF/PF), SKD-B512L/P, SKD-B512LF/PF, SKD-5200L/P, SKD-5300L/P, SKD-5200PF/LF, SKD-B519L/P, SKD-BE512L/P, SKD-BE519L/P, SKD-BE517LF/PF, SK-3120L/P(two color), SK-3180L/P(two color),
KC-7C(S)	SKD-B830P/L, SKD-B850P/L, SKD-B830PF/LF, SKD-BE830P/L, SKD-BE850P/L, SKD-BE830PF/LF,
KC-9C(S)	SKD-B100L, SKD-B103L,

ESD need special order (S) series

ACCESSORIES

KW, PG, LG, KL, KB, Series 【KW-1/3/4, PG-1, 8, 11, 12 / LG-2, 8, 11, 12】
 【KL-2000/KL-1200/KL-600, KB-1/2/3】



Torque Adjuster

	Applicable Models				
KW-1	SK-8130L/P, SK-8230L/P, SK-9130L/P, SK-9230L/P, SK-9131P/L, SKD-7000L/P, SKD-8300L/P, SK-2125LS, SK-2125LSF, SKD-B830L/P, SKD-BE830L/P	SK-8140L/P, SK-8240L/P, SK-9140L/P, SK-9240L/P, SK-9131P/L, SKD-7200L/P, SKD-8400L/P, SK-2135LS, SK-2225LS, SKD-B850L/P, SKD-BE850L/P	SK-8150L/P, SK-8250L/P, SK-9150L/P, SK-9250L/P, SK-9231L/P, SKD-7800L/P, SKD-8500L/P, SK-2145LS, SK-2235LS, SKD-B830L/P, SKD-BE830L/P, SKD-BE850L/P, SKD-BE830L/P, SKD-BE850L/P, SKD-BE830L/P	SK-8130L/PF, SK-8230L/PF, SK-9130L/PF, SK-9230L/PF, SK-9231L/PF, SKD-7800L/PF, SKD-8300L/PF, SK-2245LS, SK-2225LSF	SK-8140L/PF, SK-8240L/PF, SK-9140L/PF, SK-9240L/PF, SK-9140L/PF, SK-9240L/PF, SK-9140L/PF, SK-9240L/PF, SK-9140L/PF, SK-9240L/PF
	SK-3120L/P, SK-3280L/P, SKD-B512L/P, SKD-BE512L/P	SK-3180L/P, SKD-5200L/P, SKD-B519L/P, SKD-BE512L/P, SKD-BE519L/P	SK-3220L/P, SKD-5300L/P, SKD-B512L/P, SKD-BE519L/P	SKD-5300L/P, SKD-B517L/P, SKD-BE517L/P, SKD-BE517L/P	
KW-3	SKD-2000L, SKD-2200L, SKD-2300L, SKD-B203L, SKD-B207L, SKD-B210L				
KW-4					

Pistol Grip

	Applicable Models
PG-1	SK-9130P, SK-9130PF, SK-9140P, SK-9150P, SK-9230P, SK-9230PF, SK-9240P, SK-9250P
LG-2	SK-9130L, SK-9130LF, SK-9140L, SK-9150L, SK-9230L, SK-9230LF, SK-9240L, SK-9250L
LG-8	SKD-B830L, SKD-B830LF, SKD-B850L
PG-8	SKD-B830P, SKD-B830PF, SKD-B850P
LG-11	SKD-BE512L, SKD-BE512LF, SKD-BE517L, SKD-BE519L
PG-11	SKD-BE512P, SKD-BE512PF, SKD-BE517PF, SKD-BE519P
LG-12	SKD-BE830L, SKD-BE830LF, SKD-BE850L
PG-12	SKD-BE830P, SKD-BE830PF, SKD-BE850P



Spring Balancer

	Applicable Models
KL-600 0.3~0.6kg	SKD-2000L, SKD-2200L, SKD-2300L, SKD-B203L, SKD-B207L, SKD-B210L
KL-1200 0.6~1.5kg	USE FOR ALL MODELS
KL-2000 1.0~2.0kg	USE FOR ALL MODELS

Screw Setter

	Applicable Models
KB-1	M1.7~2.0 Screw available
KB-2	M2.0~2.6 Screw available
KB-3	M3.0~4.0 Screw available

